

VICUÑA
HERRAMIENTAS TÉCNICAS

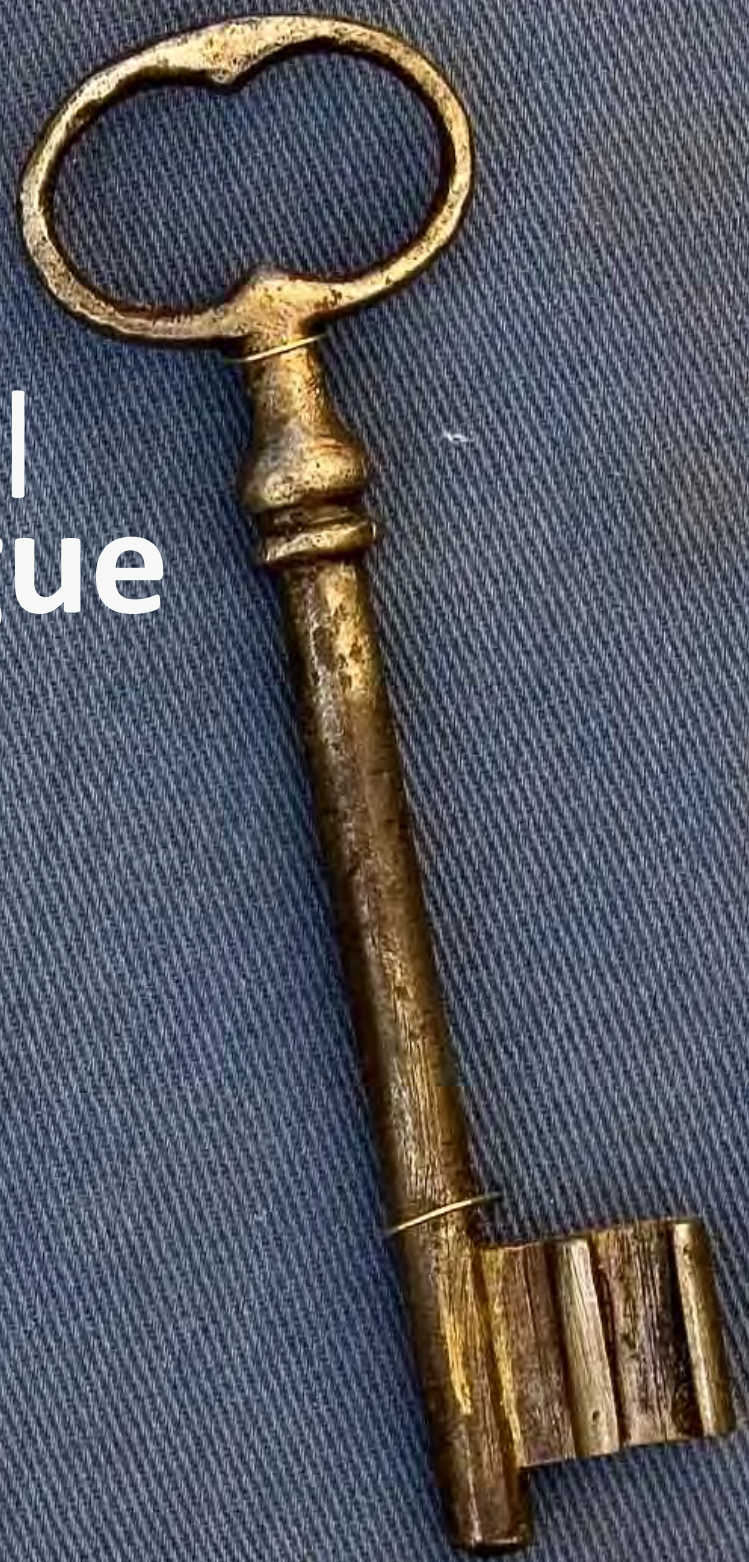

International Tool Catalogue



English Version



www.vicunatools.com

ZIEH-FIX® Tool Kit "Bell" (Basic)

ref. 1104-g

The Tool Kit

The hard-top case with handle and carrying belt contains the most common use tools for the door opening!
The tools are arranged in foam-lined interior.

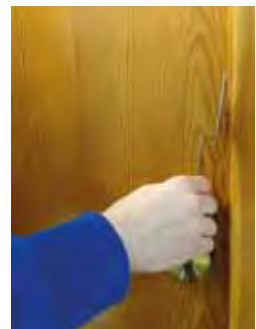
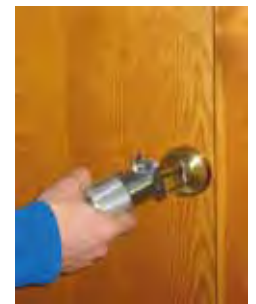

The Tool Kit contains:

Ref.	Description	Quantity
1104 k	Outdoor Case, black without content	1
1084 m	Power Cracker Master Professional	1
00231	ZIEH-FIX® "Bell"	1
00471	Door Latch Opening Card Set	1
01005ra	Proxxon-Speeder Ratchet, width across flats 17&19	1
00212	Plastic Profile Cylinder Key	1
00234	Door Latch Opening Needle Set	5
1084 t	Cracker Fixing Screw	4
00214	ZIEH-FIX® Pull Screw "Extra" 4,2 mm.	20
00215	ZIEH-FIX® Pull Screw "Super" 4,8 mm.	20
00216	ZIEH-FIX® Pull Screw "Special" 5,4 mm.	20
00203	ZIEH-FIX® Plug Extractor Plate for profile cylinder	1
		5

ZIEH-FIX® Tool Bell ref. 00231

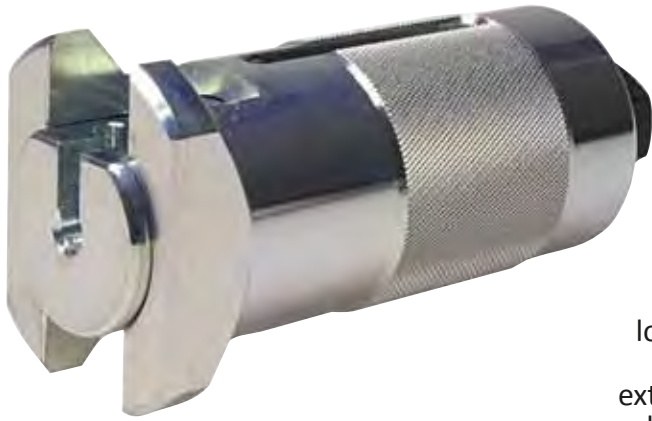

Professional tool for the plug-pulling and destruction of profile, round and oval cylinder locks

This special tool, developed for locksmiths and governmental agencies, allows the easy and efficient removal of any type of (profile, round and oval) cylinder locks. The "BELL" allows the fast opening of doors without damaging the door or the door guard. Using the plug extractor plates for the pulling of plugs, it is also possible to only remove the plug itself from the cylinder, allowing quick and easy access to the locking mechanism.

Tool Kit Bell ref. 1105



The Tool Kit contains:

Ref.	Description	Quantity
1105k	Carrying Case for "Bell", without contents	1
00231	"Bell"	1
00203	Plug Extractor Plate for profil cylinder 14,7 mm	1
00204	Plug Extractor Plate for round cylinder 16,8 mm	1
00205	Cutting- and Lubricating Spray 100 ml.	1
00206	Graphite for Lift Screws	1
1105ra	Proxxon-Speeder Ratchet, width across flats 17 x 19	1
00209	Pointed Pliers, straight	1
00212	Plastic Profile Cylinder Key	1
00214f	Pull Screw Special 3,9 mm	50 units
00214	Pull Screw Special 4,2 mm	50 units
00215	Pull Screw Special 4,8 mm	50 units
00218	CD demo	1
00810	Bit-Holder with T-Handle for bits 1/4"	1
1402	Bit Set, 1/4", 9 bits with magnetic bit extensión	1

The "BELL" often is the only effective manner of a time-saving emergency-opening, especially in the case of multiple-bolt locks and half cylinders (cylinders that only contain 1 plug and can only be opened from one side of the door), as commonly used for example in glass-doors, garage-doors, alarm systems and shades.



ZIEH-FIX® Premium ref. 00701

Plug extraction on profile cylinders as well as tearing apart the bridge possible.

Most powerful extraction tool out of our catalogue.



ZIEH-FIX® Premium Tool Kit ref. 00701m

Premium Tool Kit

With ZIEH-FIX® Premium the traction force is increased by the conception of the tool. It is sufficient to pull the lock into the tool opening and break the profile cylinder through tilting and bending movements. High-quality multiple-bolting locking systems will make it necessary to extract only the cylinder core. The tool was developed in cooperation with security- and rescue teams for the use in this field.



The tool kit contains

Ref.	Description	Quantity
1102k	Carrying Case for "Bell", without contents	1
00701	ZIEH-FIX® Premium	1
00205	Cutting- and Lubricating Spray 100 ml.	1
00206	Graphite for Lift Screws	1
00209	Pointed Pliers, straight	1
00212	Plastic Profile Cylinder Key	1
00214f	Pull Screw Special 3,9 mm	50 units
00214	Pull Screw Special 4,2 mm	50 units
00215	Pull Screw Special 4,8 mm	50 units
00218	CD demo	1
00810	Bit-Holder with T-Handle for bits 1/4"	1
1103	Protection Plate (PVC)	1
1402	Bit Set, 1/4", 9 bits with magnetic bit extension	1

ZIEH-FIX® Pull Screws

Pull Screws specially made to bear strong pulling. To be used with next:

Ref. 00202, 00701, 00700, 00231, 1105

To be used with Bit-Holder with T-Handle for bits 1/4" (ref. 00810)

Ref. 00214

ZIEH-FIX®-Pull Screws, Special
Ø 4,2 mm, 32.000 N
25 & 50 units bag



Ref. 00215

ZIEH-FIX®-Pull Screws, Standar
Ø 4,8 mm, 38.000 N
25 & 50 units bag



Ref. 00216

ZIEH-FIX®-Pull Screws, Extra
Ø 5,5 mm, 42.000 N
25 & 50 units bag

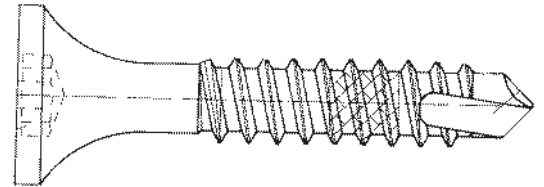

Ref. 1200

Washer for ZIEH-FIX® Pull Screw

For use with ZIEH-FIX® "Bell" (5 pieces) and references 00202, 00701, 00700, 00231 and 1105.



Ref. 1205

ZIEH-FIX® Pull Screw "Pittbull"

M6 dia.
This screw can stand a tensile strenght of 5000 kgs.
(25 & 50 units bag) to use with references 00202,
00701, 00700, 00231 and 1105.



Screw-driving adapter for the special pull-screws

Ref. 1403-esh

Screw-driving adapter for the one-handed screwing of the special pull-screws. 1/4", with Bit Tx20

The exchangeable standardized bit makes the tool useful for any type of screws. For the use with automatic screw machines etc.



Power Pull Cracker for Profile Cylinder ref. 1084-pull

This tool makes a strong connection with the lock and enables a fast breaking off of minimal jutting out locks

- o Adjustable
- o With interior profile for a better grip
- o Additional drill hole makes the use of pull screws possible



Power Cracker Master Professional ref. 1084m

This tool makes a strong connection to the lock and enables a fast breaking off of jutting out locks.

New!



Cracker for round cylinder

This extraordinary tool makes a strong connection to the lock and enables a fast breaking off of jutting out round cylinder locks.

Available in these measures:

ref. 1084m22	22 mm Ø
ref. 1084m27	27 mm Ø
ref. 1084m28	28 mm Ø
ref. 1084m32	32 mm Ø



New Power Cracker ref. 5050

This new tool makes a strong connection to the lock and enables a fast breaking off of jutting out locks.



New!

Lock Cracker Adapters

Lock Cracker Adapter for profile cylinder



ref. 5053



ref. 5054

Lock Cracker Adapter for round cylinder



ref. 5052

Lock Cracker Adapter for oval cylinder



ref. 5055



ref. 5056



ref. 5057



Special Power Cracker Adaptor

ref. 5051

Special Power Cracker Adaptor

New!



Cylinder Protection Kit

ref. 5040

4-Cylinder Protection Kit. In 2 measures:

1 mm thick
3 mm thick

New!



Ratchet Proxxon Speeder

ref. 1005 ra

Proxxon-Speeder Ratchet, width across flats 17 and 19





Door Latch Opening Needle Set "Latch Slider" for Flight Doors

ref. 1085-SH-F

Double angle slider set with two needles for left and right closing doors, which shall be opened in the direction to the user.



Door Latch Opening Needle Set

ref. 00234

High-quality nickel-plated steel wire, which have to be bend in the desired shape to fit in the door rabbet. The set includes 5 needles. For the easy opening of "only" closed but unlocked doors. Small, very efficient and almost indestructible set of needles.

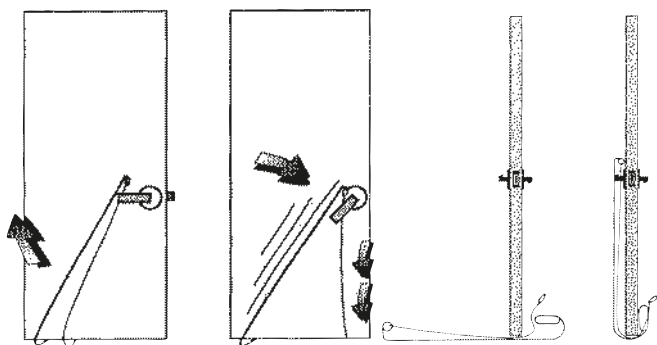
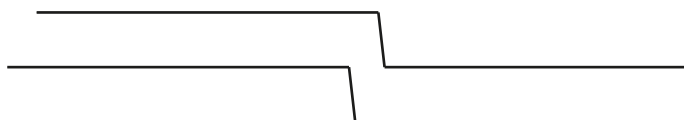

Lever Opening Tool

ref. 00240

Opens Any Door With A Lever Handle.

The tool is designed to open any door which incorporates a lever handle. If you can slide this tool under the door, you will open it in seconds.

Makita Cordless Grinder 18 Volt

ref. BGD800RFE



Specifications:

Collet (∅).....3 - 8 mm
 Grinding tool (∅) max.38 mm
 No load speed.....25.000 min-1
 Battery.....18 V / 3,0 Ah
 Weight.....2,0 kg
 Dimensions (L x W x H).....400x79x118 mm

Accumulator Straight Grinder V28 ref. HD 28 sg 0

Handy 28 Volt Accumulator Straight Grinder, ideal for milling the cylinder plug and the protection rosette.

Technical Data:

Battery capacity 28 V / 3.0 Ah

No-load torque 1. / 2. Gear

19,000/22,500 rpm

Maxi. Grinder pencil-Ø 25 mm

Weight (with battery) 3.05 Kg

LITHIUM BATTERY!



Cordless Angle Grinder ref. HD 28 ag

With a 28-volt motor and M28™ LITHIUM-ION battery, it delivers the speed (8,000 RPM) and power needed for fast grinding and cutting applications with longer run time

Technical Data:

28V™ motor delivers 8000 RPM no load speed

Overload protection for preventing over-heating

LITHIUM BATTERY!



Accessories for Front Grinder

Milwaukee, Accumulator 14.4 Volt / 2.4 Ah
ref. 1727

Battery-Pack:

14.4 Volt (System 3000)

Capacity: 2.4 Ah

Battery Type: NiCd



Milwaukee, Mobile Akku Charger 12/24 Volt
ref. 1737

With plug for cigarette lighter

Charge time Akku 14,4 V / 2,4 Ah: approx. 65 minutes

Milwaukee, Akku Charger
ref. 1738-mw

New Akku Charger 220v



Steel Burrs



Hard Steel

6 x 25 x 60

ref. 00493



Hard Steel

6 x 25 x 80

ref. 00494



Hard Steel

6 x 25 x 100

ref. 00495



Hard Steel

6 x 25 x 120

ref. 00496



Hard Steel

6 x 25 x 150

ref. 00497



Burr, Ø 3.0 mm, 60 mm Length

ref. 1721



Collet for Grinders, Ø 3 mm

ref. 1728



Burrs for Aluminium

ref. 00497a

Hard Steel Burr 60 mm.



Burr for tubular locks

ref. 00499

Round Burr with centering guide Ø 10 mm.

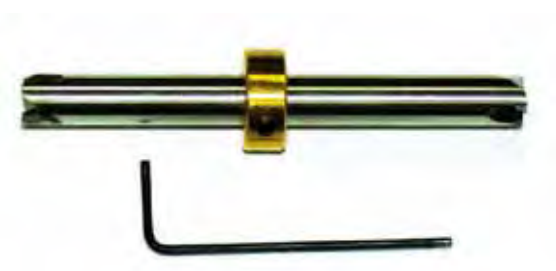

Cobalt Crown

ref. wh28fresa

Ø 7.5 mm. and Ø 9.2 mm Cobalt Crown with depth stop.

You can use it with ref. wh28c09 and ref. wh28c10

Drills

A drill bit specifically to penetrate hard steels and alloys. Especially useful for drilling hardplate and drill resisting plate encountered by locksmiths and safe engineers.



ref. 00014	6,0 mm x 100 mm.
ref. 00015	4,0 mm x 75 mm.
ref. 00016	5,0 mm x 85 mm.
ref. 00017	5,0 mm x 150 mm.
ref. 00018	6,5 mm x 100 mm.
ref. 00019	6,5 mm x 150 mm.
ref. 00012 New!	7,0 mm x 100 mm.
ref. 00020	8,0 mm x 120 mm.
ref. 00021	8,0 mm x 200 mm.
ref. 00022	10,0 mm x 120 mm.
ref. 00023	10,0 mm x 200 mm.
ref. 00024	10,0 mm x 300 mm.
ref. 00025	13,0 mm x 150 mm.
ref. 00026	13,0 mm x 300 mm.
ref. 00027	13,0 mm x 600 mm.



Solid Carbide High-Speed Drill, 6.0 mm dia., 60 mm Length



ref. d 0660

The solid carbide high-speed drill is made of 100% carbide and distinguishes itself in a high durability.

Burrs for Impression Technique

Special Burrs for Impression Technique



ref. 00527 4 mm.

ref. 00528 5 mm.

Lever Picks

New sizes for lever picks for the opening of small cabinet locks, and so on.



Pick Set Large

ref. 00426

Large size (2, 3 and 4 levers). To access doors, basements, storage rooms, and so on.

Pick Set Mini

ref. 00426a

For locks of antique furniture.

Pick Set Micro

ref. 00426b

For locks of antique furniture.

Padlock Shim Pack ref. 00327

Opens Almost Any Lock With A Spring Lever Latch Locking Bar.

An assortment of 20 padlock shims designed to quickly and effectively open many of snap-shut type economy padlocks on the market.

Their speciality is opening laminated type padlocks though they will open almost any lock which has a spring lever latch locking bar providing there is enough clearance to allow the shim to operate.

- o Simple to use
- o Contains 5 Each of 4 Most Common Shackle Diameters
- o Works on most single latched padlocks
- o Stainless Steel Components



Lever Key Set ref. 00869

Key set for lever locks and cylinders.



Cone Aid ref. 00230

Aid for cylinder extractors.
It's ideal when a cone protector gets difficult the extractor task.



New Pick Set ref. AML020066

The new Pick Set contains 13 picks instruments and 7 different function tension tools to fit different cylinders.

New!



Magic Key Set

New Tool to open double bitted lever lock

ref. magic key

•Set with self-impressioning keys.

Specially designed keys with movable pins for each lever.

Insert the impression key into the lock and rotate all the way to the stop and stay in touch. With swinging movements the movable pins can be brought into the necessary position to open the lock.

Ideal to open CISA, MIA ATRA , CR, MCM, LINCE, JUWEL, CAM, RODES, SECUREMME, SECUREMME BOX, MOTTURA NUCLEO COMPACT, MOTTURA NUCLEO (OLD), POTENT 7000, POTENT EASY SWIFT, CIFIAL, KLASS, GARDIAN, ELBOR, CISA (LITTLE) , MOTURA 2 TURNS, MOTTURA CENTERED LEVELS, FIAM, UCEM 2 TURNS & LATCH, UCEM 4 TURNS, CAM 3+3, CISA EASY SWIFT, AGC, STAVR (LATVIJA), ARFE SAFE , ARFE ELECTRONIC SAFE, CISA SMALL SAFE TO INLAY, ARREGUI SMALL SAFE TO INLAY, BODA-428, BORDER, ABLOY and many more.

The Basic Set contains:

- 10 pieces
- 2 pcs. Handle
- 1 pc. Assembly Pin
- 30 pcs. Movable Pins
- 1 case

New!

Our brand new MINI SET MAGIC KEY is now available for locksmiths.



Available designed keys:

- 1 pc. Magic Key 1 for Mottura 6+6
- 1 pc. Magic Key 2 for Mottura +6+ - Nucleo
- 1 pc. Magic Key 3 for Mottura 3+3
- 1 pc. Magic Key 4 for Securemme 6+6
- 1 pc. Magic Key 5 for Securemme 3+3
- 1 pc. Magic Key 6 for Cisa 3+5+3
- 1 pc. Magic Key 7 for Cisa 3+3
- 1 pc. Magic Key 8 for CAM 4+4
- 1 pc. Magic Key 9 for Gardian 4+4
- 1 pc. Magic Key 10 for Elbor 3+3
- 1 pc. Magic Key 11 for ELP 6+6 (Kazan)
- 1 pc. Magic Key 12 for Potent 7000 7+7
- 1 pc. Magic Key 13 for Mottura +7+ Safe
- 1 pc. Magic Key 14 for ISEO +6+
- 1 pc. Magic Key 15 for ISEO Fiam 6+6
- 1 pc. Magic Key 16 for Mul-T-Lock Matrix 6+6
- 1 pc. Magic Key 17 for ELP 3+3 (Kazan)
- 1 pc. Magic Key 18 for Serrature 6+6 magnetic rotor system
- 1 pc. Magic Key 19 for Technomax casseforti 4+4
- 1 pc. Magic Key 20 for Potent Viper +8+
- 1 pc. Magic Key 21 for Ezcurra 10 pins
- 1 pc. Magic Key 22 for FAS 309, 318 +9+
- 1 pc. Magic Key 23 for KALE 4+4
- 1 pc. Magic Key 24 for Ezcurra 6 + 6
- 1 pc. Magic Key 25 for Mottura 3+3 (4+4)
- 1 pc. Magic Key 26 for MCM 3+3 Caja Fuerte
- 1 pc. Magic Key 27 for FAG +4 Caja Fuerte
- 1 pc. Magic Key 28 for Potent 2500 14 pins
- 1 pc. Magic Key 29 for Tesio 6+6
- 1 pc. Magic Key 30 for Stop 6+6 (Chaina door)
- 1 pc. Magic Key 31 for Erevan 4+4
- 1 pc. Magic Key 32 for MOIA 6+6
- 1 pc. Magic Key 33 for Mottura Nucleo (ball) My key
- 1 pc. Magic Key 34 for Safe +6+
- 1 pc. Magic Key 35 for IDM
- 1 pc. Magic Key 36 for Era +5
- 1 pc. Magic Key 37 for Gardian 3+3
- 1 pc. Magic Key 38 for Cerutti +6+
- 1 pc. Magic Key 39 for Fiam F39
- 1 pc. Magic Key 40 for Acutra 2+2 (Argentina)
- 1 pc. Magic Key 41 for Teache 2+2 (Argentina)
- 1 pc. Magic Key 42 for Trabe 2+2 (Argentina)
- 1 pc. Magic Key 43 for Fiam F40 (10 lever)
- 1 pc. Magic Key 44 for Iseo 3+3
- 1 pc. Magic Key 45 for Gardian 2514 5+5
- 1 pc. Magic Key 46 for Potent safe 3+3
- 1 pc. Magic Key 47 for Elzet +5 ,5+ (Hungary)
- 1 pc. Magic Key 48 for Klass 3+3
- 1 pc. Magic Key 49 for SMP safe +9+ (England)
- 1 pc. Magic Key 51 for MOTTURA 6+6 (+-profile)



Kitbor. Chubb Lock Opening Set ref. 00190



With this tool it is possible to open high security systems with double bitted key destruction-free and to produce a duplicate key.

Hold tension to the bolt mechanism of the lock with a counterbalance bar and counterweights. Now move with the sensing device every individual lever of the lock to the right position that is necessary to open the lock.

At the sensing device is also an index finger. On the basis of the template installed at the lock, the index finger shows the key cut depth that is necessary to duplicate a key.

The set contains:

Kitbor Bolt Tension Tool for CR 2251; MOTTURA 771, 571, 42751, EZCURRA M70, MCM: 1.108, 1.813, 808; META; FAC: 480; LINCE:25610, 25600; CISA: 57010, 57018, 57211, 57220, 57250, 57255; JUWEL-UCEM: 1004, 1006, 1108, 1176; FIAM: 3136; SAAB: 510; SECUREMME: 2000, 2002

We highly recommend our Kitbor seminar for a better use of this tool.

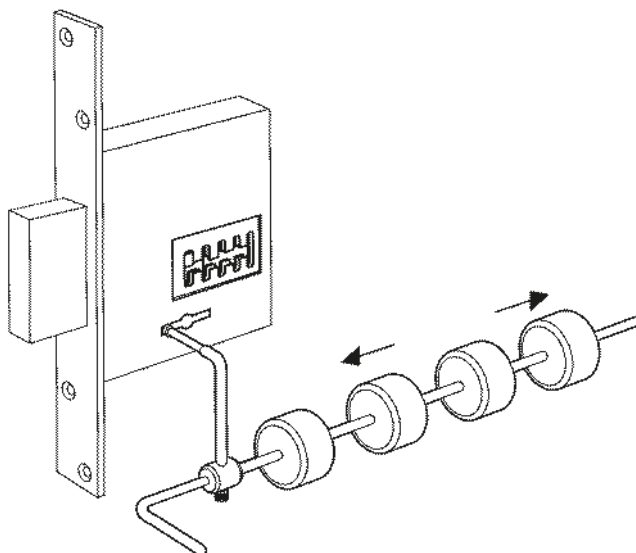
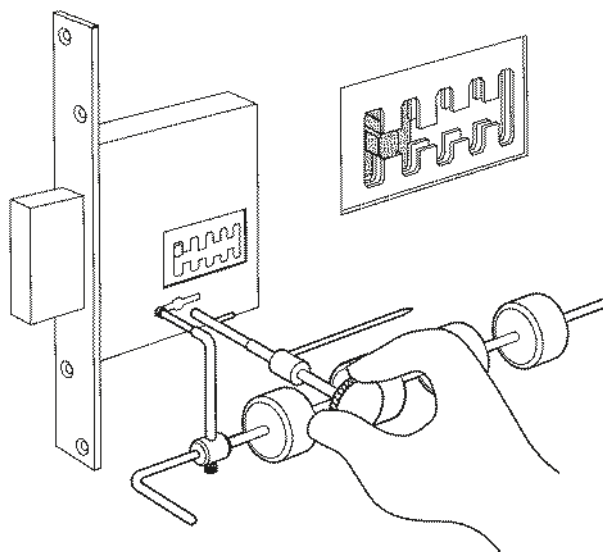
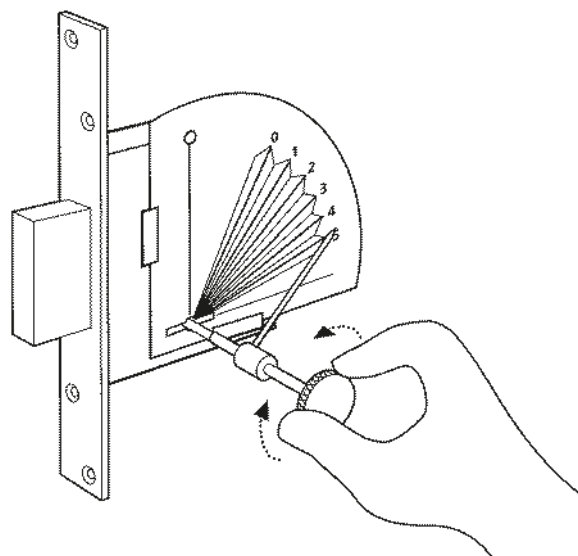

Kitbor Bolt Tension Tools

Not included in the Kitbor Set

Bolt Tension tool for Mottura mod. 771 New

ref. 00120

Bolt Tension tool for Mett3m

ref. 01020kit

Bolt Tension tool for CR mod. 2251/28

ref. 01022

Bolt Tension tool for CISA 57115 (with special sensing device)

ref. 01023

Bolt Tension tool for CISA 57535/57685

ref. 01023V

Bolt Tension tool for Rodes

ref. 01028

Bolt Tension tool for Mottura mod. 779

ref. 01029

Bolt Tension tool for SAB mod. 1580 (with special sensing device)

ref. 01040

Bolt Tension tool for Sab Meroni 510

ref. 01041

Bolt Tension tool for Cerruti

ref. 01042

Bolt Tension tool for Mauer Dekaba 8 lever

ref. 01043

Opening Kit for Acytra

ref. 01045

Bolt Tension tool for Kale Kilit 257L

ref. 01046

Opening Kit Big Ezcurra

ref. 01047

Bolt Tension tool for Lince 21631/ 21630

ref. 01048

Bolt Tension tool for Mia Atra

ref. 01049



Lever Pick Set

Lever Pick Set "D", Furniture & cabinet locks

ref. 1813

21 Lever Picks for Chubb Locks, high quality Furniture and cabinet locks Set. Hole inside diameter: 3,7 mm
Bit height: 14 mm. Total length: 60 mm
Shaft length: 40 mm. Shaft diameter: 6 mm

Lever Pick Set "K", Chubb locks Set

ref. 1821

Chubb locks Set 12 pieces
Total length: 100 mm
Bit height: 14 mm. Bit length: 10 mm
Shaft length: 80 mm. Diameter Hollow shaft: 5 mm

Lever Pick Set "O", Warded and antique locks Set

ref. 1825

Warded and antique locks Set 15 pieces
Total length: 110 mm
Bit height: 12 - 15 mm. Bit length: 9 - 14 mm
Shaft length: 80 mm. Diameter Hollow shaft: 5 mm

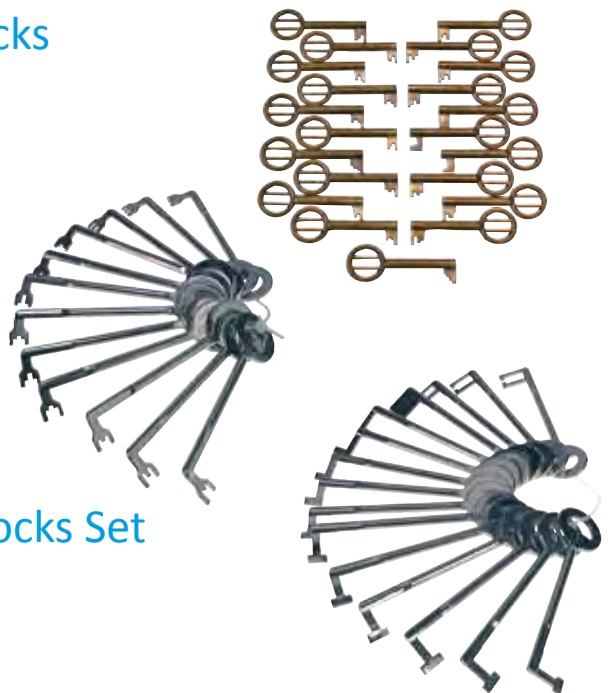

Kit Picks 2 in 1 ref. 6070



New!

12 picks kit 2 in 1. With this tool it is possible to open systems with double bitted key destruction-freely .

PICK 1	Bricard 4/6 lever locks Laperche 6 lever locks Debeaurin/Metalux 6 lever locks Debeaurin/Metalux 4 lever locks Vachette 6 lever locks	ref. 6070.01
PICK 2	FTH 4 lever locks	ref. 6070.02
PICK 3	JPM 4 lever locks	ref. 6070.03
PICK 4	Laperche 4 lever locks Vachette 4 lever locks	ref. 6070.04
PICK 5	FTH/JPM/Debeaurin/Metalux 4 lever locks	ref. 6070.05
PICK 6	Debeaurin/Metalux 4 lever locks (down)	ref. 6070.06
PICK 7	Debeaurin/Metalux 4 lever locks (up)	ref. 6070.07
PICK 8	Bricard 4 lever locks (mortised 40)	ref. 6070.08
PICK 9	Bricard 4 lever locks (mortised 50)	ref. 6070.09
PICK 10	FTH 3 lever locks	ref. 6070.10
PICK 11	JPM 4 lever locks (embutidas)	ref. 6070.11
PICK 12	Laperche 3 lever locks	ref. 6070.12

New!

Drill Patterns

Drill patterns for lever and Fichet locks.
Easy & Quick system.
The best choice for this kind of locks!



ref. 5651

Drill Pattern for V-shaped Fichet locks. Models 450, 480 and 484.



ref. 5652

Drill Pattern for V-tilted shaped Fichet locks. Model 666.



ref. 5653

Drill Pattern for Fichet locks. (replacement HLM doors)



ref. 5654

Drill Pattern for Mottura lever locks.



ref. 5655

Drill Pattern for Atra- Dierre lever locks.



ref. 5656

Drill Pattern for CR lever locks.

Decoder Ezcurra ref. 1034

The decoder for "EZCURRA" locks with picking protection works after the principle of the "Hobb`sche Hook".

The ingenious mechanics avoids the picking protection.

o for especially lever locks



Broken Keys Extraction Set ref. 00793

This extraction set let you get broken pieces of keys and other objects from the keyhole. Easy to use.

ref. 00774

Spare part with handle.



Cork Screw Door Latch Retractor Set

ref. 1076

Especially suitable for doors with sticking out seals, which has made an introducing from opening needles impossible until now. The cork screw door latch retractor pierces these sticking out seals and makes it possible to slip the latch!

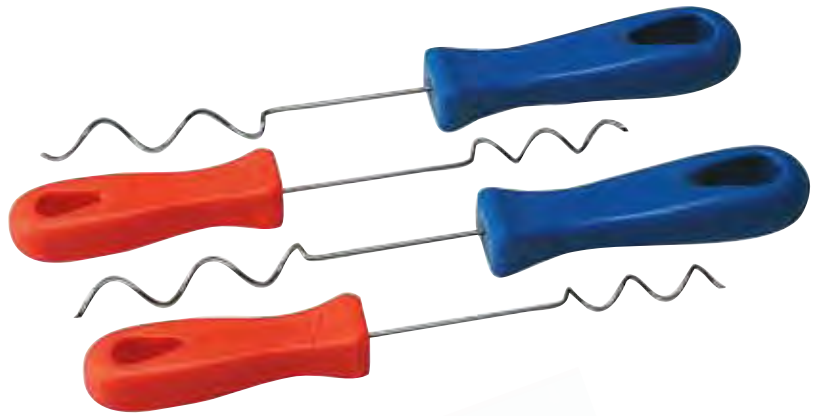

Two-Metal Crown

Hollow crown ideal for drilling lever and pump locks.

ref. CB14

14 mm. outer diameter Standard

ref. CB40

40 mm. outer diameter and 70 mm. Inner Background

ref. CB51

51 mm. outer diameter and 70 mm. Inner Background

ref. abloy-pro-fas

Burr for Abloy Protec-Locks



Opening Special Locks Kit

ref. 00490



The tools in this set are especially designed to open special locks type H. It includes a cutting crown welded in cold in order to avoid getting hot, and a repairing kit for later placement.

Measure of the cutting crown: 51 x 70 mm

Optional

ref. 00491

It includes a golden hard steel protector and a polished coating ring.



before unlocking.

after unlocking and placement our repairing kit.



Guide and cutting action



Once cut, get out the centering guide and go on cutting hard plate.



After the arriving the hard plate, get out the protector and unscrew the cylinder. Time used: 7 minutes.

ref. 00489

Centering tool Kit

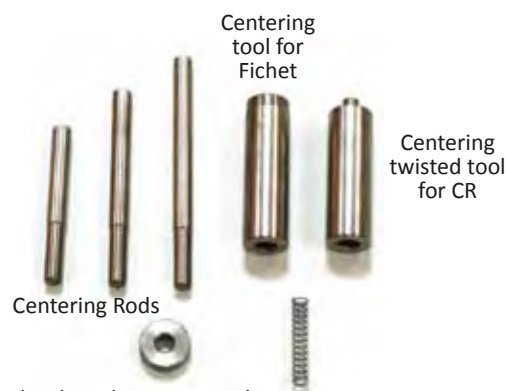

Centering Rods

Centering tool for Fichet

Centering twisted tool for CR

A hard steel protector to be used along with the centering tool for CR

Plug Spinners

Use the plug spinner to rotate the plug super fast in the right direction without relocking if you have picked the cylinder in the wrong way.

Simply pre-set the nose, insert the blade in the keyway of the lock and press the button.

Flipper

ref. 00293w

The cylinder plug accelerator "Flipper" is used after successful picking the lock with. The accelerator is thrilled according to the necessary rotation direction and removes the cylinder plug after release of the tension in a fast rotation, so that the pins don't drop back into the pin's drill holes of the cylinder housing and will possibly lock.

The "Flipper" will flip the cylinder plug past the upper pins and save you the job of repicking.

The "Flipper" comes with two exclusive features. The two pins, quick lock/release feature allows for easy release of the rotating action. The sure stop feature prevents over-winding in either direction.



Gun Plug Spinner

ref. 00292

The spinner's heavy duty torsion spring and loading pin allow for rotating in either direction at varying strengths and speeds, making sure you only have to spin once. Plus, the easy to hold gun-like grip allows for perfect control when spinning the plug on a picked lock is required.

This tool is especially well suited for spinning locks that include the extra pressures supplied by plug return springs and is the only one turning tool in the world that can adjust spin strength.



"Little Joe" II Gun Plug Spinner

ref. 0555-rgn-flp

Perfect For Spinning Light To Heavyweight Lock Plugs.

The spinner's heavy duty torsion spring and loading pin allow for rotating in either direction at varying strengths and speeds, making sure you only have to spin once. Plus, the easy to hold gun-like grip allows for perfect control when spinning the plug on a picked lock is required. This tool is especially well suited for spinning car locks that include the extra pressures supplied by plug return springs and is the only one turning tool in the world that can adjust spin strength. This model is specifically made for the use with "Little Joe".



New Spinner

ref. 10097

This spinner's is great because of its heavy duty torsion spring

New!





Pick Sets KGB ref. 00328

- o Shirt Pocket Size (Closed): 3-1/2" x 2-1/4"
(9 x 5.75 cm)
- o Genuine Leather Case with Snap
- o Contains 3 Picks, 2 Tension Tools and 1
Extractor
- o Hardened Spring Steel and Stainless Steel
Components



Tyro ref. 00303

- o Shirt Pocket Size (Closed): 1-3/4" x 5-5/8"
(4.5 x 14.5 cm)
- o Top Grain Leather Case with Snap
- o Contains 6 Picks, 2 Tension Tools and 1
Extractor
- o Hardened Spring Steel Components



Novice ref. 00304

- o Shirt Pocket Size (Closed): 1-3/4" x 5-5/8"
(4.5 x 14.5 cm)
- o Top Grain Leather Case with Snap
- o Contains 7 Picks, 3 Tension Tools and 1
Extractor
- o Hardened Spring Steel Components

Pick Sets

OH-8

ref. 00314

o Shirt Pocket Size (Closed): 2-5/8" x 6" (7 x 15.25 cm)

o Genuine Leather Case with Full Zipper
o Contains 8 Picks, 2 Tension Tools and 1
Extractor Set

o Hardened Spring Steel Components



Pick Set 2000

ref. 00306

o Shirt Pocket Size (Closed): 2-5/8" x 6-3/8" (7 x 16.5 cm)

o Genuine Leather Case with Full Zipper
o Contains 9 Picks, 4 Tension Tools
and 3 Extractors

o Hardened Spring Steel Components



De Luxe NDPK

ref. 00296

o Shirt Pocket Size (Closed): 2-5/8" x 6-3/8" (7 x 16.5 cm)

o Genuine Leather Case with Full Zipper
o Contains 10 Picks, 4 Tension Tools
and 2 Extractors

o Hardened Spring Steel Components



Estuches de Ganzúas

ID Badge
ref. 00301



- o Shirt Pocket Size (Closed): 3" x 5-1/2" (8 x 14 cm)
- o Genuine Leather Case with Snap
- o Contains 12 Picks, 2 Tension Tools and 4 Extractors
- o Hardened Spring Steel Components

On Call
ref. 00314a



- o Shirt Pocket Size (Closed): 3-1/4" x 6" (8.25 x 15.25 cm)
- o Genuine Leather Case with Full Zipper
- o Contains 16 Picks, 2 Tension Tools and 2 Extractors
- o Hardened Spring Steel and Stainless Steel Components

Pro Mixer NDPK-24
ref. 00297



- o Shirt Pocket Size (Closed): 2-5/8" x 6-3/8" (7 x 16.5 cm)
- o Genuine Leather Case with Full Zipper
- o Contains 14 Picks, 5 Tension Tools and 5 Extractors
- o Hardened Spring Steel and Stainless Steel Components

Estuches de Ganzúas Superior NDPK-32 ref. 00298

- o Shirt Pocket Size (Closed): 2-5/8" x 6-3/8" (7 x 16.5 cm)
- o Genuine Leather Case with Full Zipper
- o Contains 22 Picks, 7 Tension Tools and 3 Extractors
- o Hardened Spring Steel Components



Professional NDPK-60 ref. 00299

- o Jacket Pocket Size (Closed): 4" x 6-1/2" (10 x 16.5 cm)
- o Genuine Leather Case with Full Zipper
- o Contains 40 Picks, 14 Tension Tools and 6 Extractors
- o Hardened Spring Steel Components



Paramount NDPK-100 ref. 00300

- o Tool Box Size (Closed): 6" x 9" (15 x 23 cm)
- o Genuine Leather Case with Full Zipper
- o Contains 72 Picks, 19 Tension Tools and 9 Extractors
- o Hardened Spring Steel Components



Pick Sets James Bond ref. 00827

- o high-quality and computer-calculated picks
- o stainless springsteel



Emergency ref. 00322a



- o Shirt Pocket Size (closed): 4-1/2 x 3/4" (11.5 x 2 cm)
- o Plastic Case
- o Spring Steel Components
- o Contains 6 Picks and 1 Tension Tool: 2 Rake Picks, 1 Diamond Pick, 1 Hook Pick, 1 Double 1/2 Ball Pick, 1 Small Ball Pick, 1 Medium Tension Wrench

Executive ref. 00312

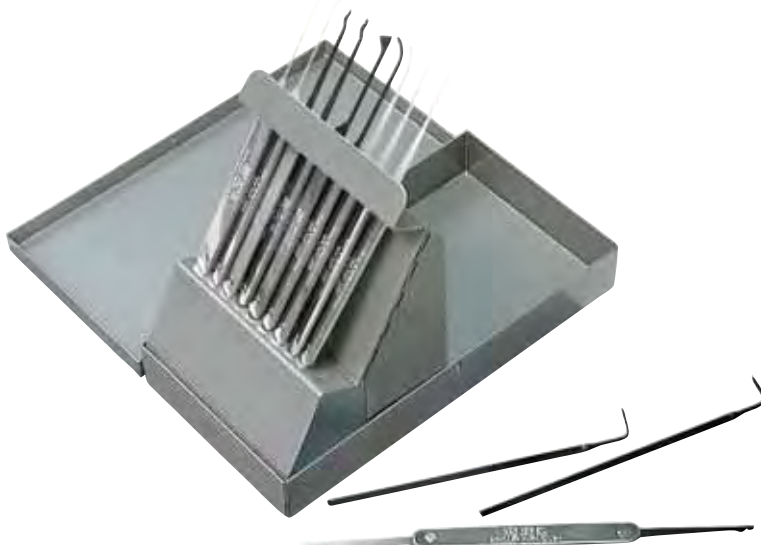

- o Tool Box Size (Closed): 3-1/2" x 6-3/4" x 1" (8.9 x 17.15 x 2.5 cm)
- o Steel Flip-Up Case
- o Contains eight 2-in-1 Picks, two 2-in-1 Extractors, and two Tension Tools
- o Picks Feature Stainless Steel Blades on 1 Side and Spring Steel Blades on the Other
- o Extractor Blades are Made of Hardened Stainless Steel
- o Tempered Spring Steel Tension Tools

Pick Sets Jackknife

ref. 00322

- o Shirt Pocket Size (Closed): 4" x 3/4" (10.25 x 2 cm)
- o Contains 4 Picks and 1 Tension Tool
- o Spring Steel Components
- o Optional Genuine Leather Case with Snap



Jackknife leather case

ref. 00323

- o Optional Leather Case (4" x 3/4") with Snap



Pen Pick set

ref. 00320

- o Shirt Pocket Size (Closed): 5/8" x 6-3/4" (1.5 x 17.25 cm)
- o Contains 14 Picks and 1 Tension Tool
- o Stainless Steel Components



Pen Pick set II

ref. rgn 3350

This pick set contains 9 most popular pick blade instruments (put inside in the handle of pen pick set) and one strong flexibility excellent tension wrench (clip).

This pick set is made of high quality materials not only through every necessary special design and every polish process to lighten and look like a high quality pen, but also it is a high quality professional pick set.



Credit Card Pick Set

ref. 3351

- This stainless steel pick set contains 6 picks, one Flat Tension Tool and one Credit Card sliding case.





Big Pick Set ref. 10074

A 31 piece Pick Set is the best for saw type and security key cylinders.

These rubber handled picks have an enhanced "feel" due to the tensile strength that seems to aid in lock picking.

Made from the finest quality stainless steel and polished in chrome.

New case!



Combi Pick Set ref. gl-206

- o 10 Handles with replacement Pick Blades
- o 4 Pick Blades for Pin and Disk Tumbler Locks
- o 5 Pick Blades for Dimple Key Systems
- o 1 Extractor Blade
- o 1 Tension Tool

Vision Pick Set 3 in 1 ref. 00211-rgn

Specially designed for Auto Lock openings, it can be used on all wafer locks.

- o View into and magnify and illuminate keyway
- o Picks wafer locks
- o Read wafer locks
- o Inspects locks
- o Safe work

The Navigator 3 in 1 Scope is the most unique locksmith scope in the market.

It not only allows viewing and reading wafer lock's functions, but also picks the lock.

It comes with 3 different sizes (6 pieces) hard depressors designed to fit into every different size wafer Locks (long, short, big,small) and 1 uniquely 1.48" long tube speculum designed for some hard-to-see areas and safe openings.

The Navigator 3 in 1 Scope is particularly effective opening auto locks.



Pick Sets Matador Secretary ref. rgn 0704

This Pick Set is designed for opening ordinary dimple key systems, is not designed to open special keyway locks. This tool set is compact and convenient which can be put on pocket.

Type: 3 kinds of different types
 Identification of type: different number of line on the brass handle
 Handle: made of high quality of brass, and polish finishing
 Blade: made of hardened steel with good flexibility

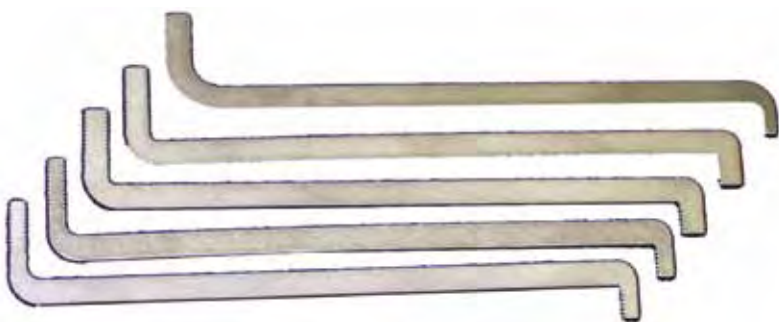

Tension Tools Set ref. P FLAT 5 The Flat-5 Tension Tool Set



Matador ref. 00295

- o for Dimple Key Systems
- o hand made picks
- o not suitable for pin-in-pin systems!

Wallet
ref. 00295E



Mul-T-Lock ref. 00324

- o Specially Designed Pick Shape
- o Supplied with Illustrated Instructions
- o Real Leather Wallet included
- o Simple to use

Picking Tools for Dimple Locks

Picking Tools for Dimple Locks. Good Quality! Easy Use! French Manufactured!

New!



Tool for ABUS D6/ ABUS EXTRA CLASSE-AB48

Tool for FTH TRANSIT/STANDERS YD7R

Tool for ISEO R6/CITY R6-IE15

Tool for HERACLES Y7/YARDENI Y6-YD7R

Tool for MUL-T-LOCK 7X7 - MTK13R

Tool for ABUS (old model)

Tool for MUL-T-LOCK INTERACTIVE IZQUIERDA

Tool for MUL-T-LOCK INTERACTIVE DERECHA

Tool for KALE 164BNE

Tool for KALE 164SN

Tool for BRICARD SERIAL (BD13)

Tool for BASI CX6

ref. 5537D6

ref. 5537FTST

ref. 5537R6

ref. 5537Y7

ref. 5537MTL7

ref. 5537AB40

ref. 5537MTLL

ref. 5537MTLR

ref. 5537164BNE

ref. 5537164SN

ref. 5537BD13

ref. 5537CX6

Some other models are in process of manufacturing. Ask for other locks!

Picking Tools for Dimple Locks

Picking Tools for Dimple Locks. Good Quality! Easy Use! French Manufactured!



New!

Tool for MCM E8

Tool for LINCE

Tool for CISA ASIX

Tool for EZCURRA DS15

Tool for YALE

Tool for CISA/BRICARD/ABUS (1)

Tool for CISA/BRICARD/ABUS (2)

Tool for CISA ASTRAL CS62

Tool for TITAN

Tool for TESA T60

Tool for VACHETTE VRX

ref. 5537E8

ref. 5537LINCE

ref. 5537CS146

ref. 5537DS15

ref. 5537YA90

ref. 5537CBA1

ref. 5537CBA2

ref. 5537CS62

ref. 5537K5

ref. 5537T60

ref. 5537VRX

Some other models are in process of manufacturing. Ask for other locks!

Super Mica

ref. 00471

- o The opening cards are manufactured out of high-flexible plastic, fit in the fold of the door and allow to slip the latch.
- o set of 5 pieces per pack in 2 different thicknesses
- o out of a material with high quality to glide
- o with additional application of silicon spray - "Fantastic Plastic"
- o works on most tightfitting doors

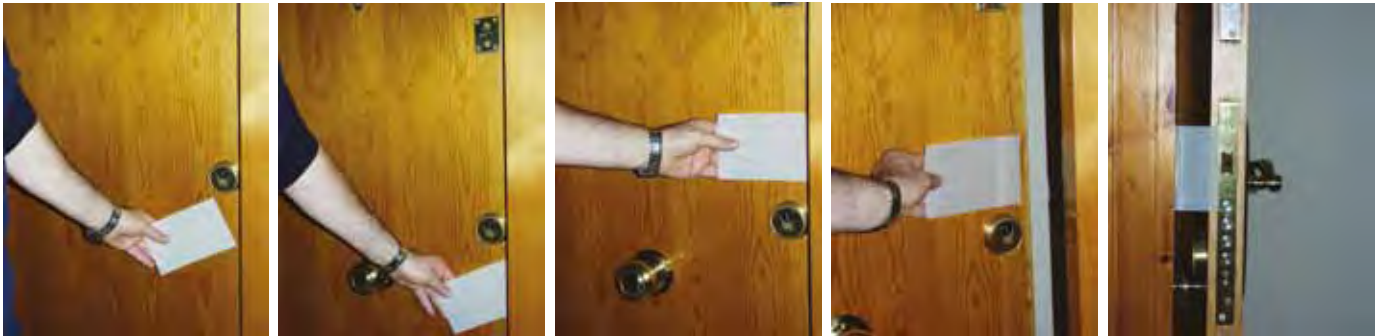
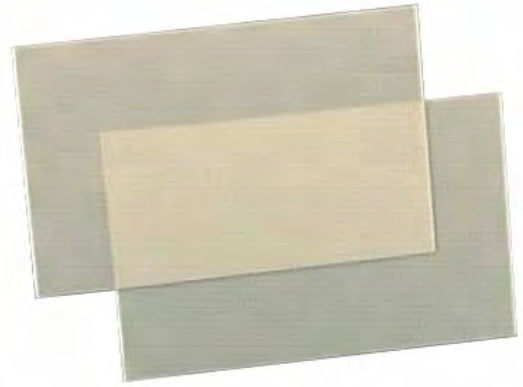

Handle for supermica

ref. 1098b

- o Handle for door latch opening cards. The handle allows a solid fix of the card. Consequently, working with bigger pressure is possible without running the risk of injuring yourself by the card.
- o The special feature is that door latch opening cards can be punched with a simple paper punch and then be fit into the handle.

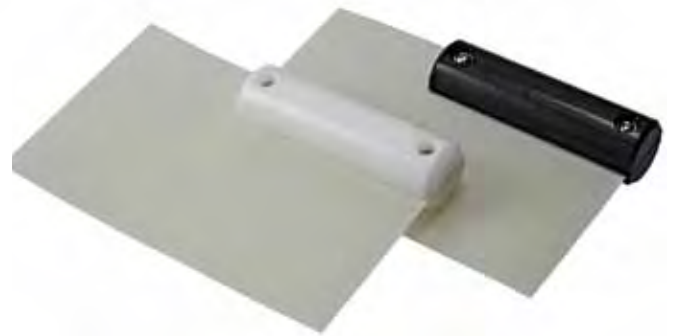
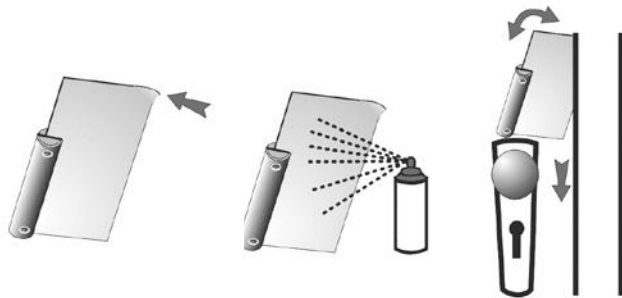

Door Latch Opening Glider

- o The Door Latch Opening gliders are made from a type of steel specifically created for their use. They allow a fast and easy opening of doors that are "only" closed, but not locked.

ref. 1078mb15

180 mm long
0,15 mm thick



ref. 1078mb20

180 mm long
0,20 mm thick

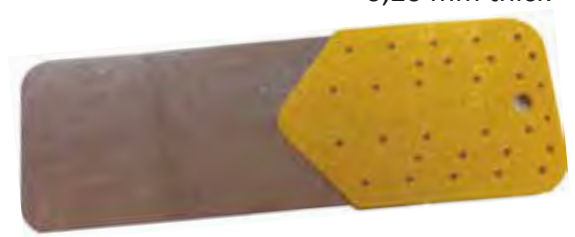

Electro Pick Set ref. 00270



The cordless rechargeable electric pick gun works after the principle "Transfer of Energy". The necessary hit frequency as well as the hit hardness of the pick is produced by an eccentric motion. That way a simple opening of pin and disk tumbler locks with several pins is possible.

The electro-pick allows to duplicate exact raking motion at many times per second. The gun rakes open pin and disc tumbler cylinders using a rapid up and down striking movement, which causes the top and bottom pins to separate, meeting the shearline.

This tool meets all future requirements through continuous new developments of pick needles and accessories from our production.

- o Developed and made in Germany
- o for high standards
- o manufactured with extremely precision
- o simple handling

The electro pick includes:

- 00271** plastic case
- 00272** charger 12v
- 2701E** straight blade
- 00288** angel blade
- 00241** straight tension wrench
- 00251** angel tension wrench
- 00264** long tension wrench
- 00265** extra long tension wrench

You can also have the complete set with the next tools:

ref. 00270-set

- 00305** Novum Pick set
- 00291** torque & tension tool
- 00292w** Flipper Tool
- 3670** Car Pick Set

Pick Set for Electro pick ref. 00285

Picks for multipoint cylinders
Recommended tool for multipoint cylinders with wide keyhole.

To be used with ref. 00270





New Electronic Pick ref. 3600EC

This tool is a modification and improvement of the ref. 00270, which has generally been part of the standard equipment of locksmith alongside one of our developed picking tools.

Over the course of the last years the manufacturers of cylinder locks have been taking technical provisions to prevent the manipulation of the lock cylinders.

The actual innovation and consequently the core piece of the ZIEH-FIX® Electronic-Pick is the new electronics, which has been completely integrated into the handle and therefore allows to regulate the high percussion frequency necessary for opening even high-quality lock systems.

Technical Specifications:

Energy Source

3 batteries, (LR14, 1.5 volt) or 4 accumulators (1.2 volt)

Idle speed percussion frequency

12,000 percussions/minute

Load alternation frequency

8,000 percussions/minute

Percussion frequency

Continuously adjustable to the response frequency of the lock

Weight

380 gr. (without energy source)

new!

Also new is the incorporated battery compartment in the handle which enables a smooth replacement of the energy source and is suitable for internationally used batteries (3 x LR14, 1.5 Volt) as well as rechargeable batteries.

In case of new developments the tools can be upgraded by re-programming them in our factory. Information to this will be published on our web page in due course.

The new handle with the incorporated electronics is available separately. Consequently all old models of the ZIEH-FIX® Electro-Pick II (with the black handle) can be altered if necessary, as the gear heads of both tools are compatible.

Beside the Electro Pick the set also contains:

ref.	description
00271	Plastic Operation Case
3600	New Electronic Pick
3516E	Pick "Novum"
3517E	Pick "Novum"
00241	Tension Tool
00251	Tension Tool
00260	Tension Tool
00263	Tension Tool

Additional useful accessories in the complete set:

ref. 3600EC-SK

ref.	description
3516E	Pick "Novum"
3517E	Pick "Novum"
00241	Tension Tool
00251	Tension Tool
00260	Tension Tool
00263	Tension Tool
3498E	Torque & Tension Tool
00292w	Flipper
00305	Novum Pick Set
3670	Car Pick Set
CD-4000	ZIEH-FIX Electro-Pick®



The handle of the new Electronic Pick is compatible with the gear head of the former model.





Plain Raker Changer for Electro pick ref. 00285a

Plain raker adjustable to Electro Pick (Ref. 00270)
Ideal in opening multipoint cylinders.



Its vibration is horizontal.



Novum pick set ref. 00305

Especially when confronted with complicated lock cylinders difficult to pick, only the use of laser-cut picks blades made from hardened spring steel may lead to success.

These pick blades can be used with the Electro Pick and with a handle. The set comes in a leather case and contains 39 picks of stainless steel (3 pcs. of each form), 1 tension wrench and 1 handle for the use as a handpick

o 13 new pick blades with special shapes can raise the probability of success!

Novum Picks

These different pick needles allow the use of the Electro Pick in locks with narrow or complex keyways and also in locks with extreme lock codes.

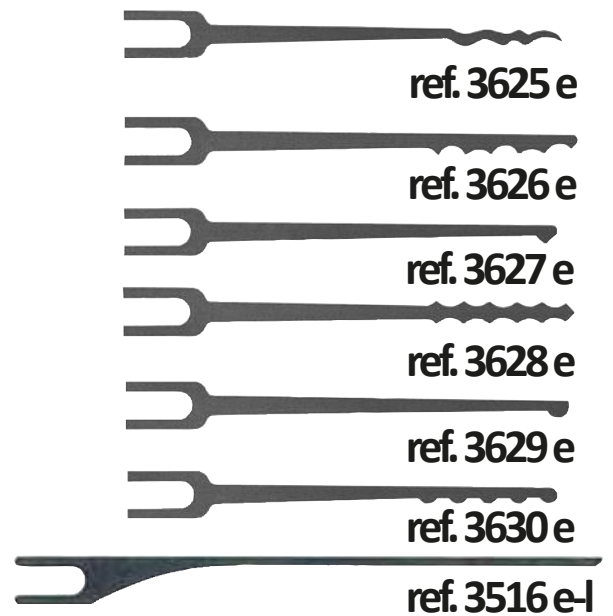
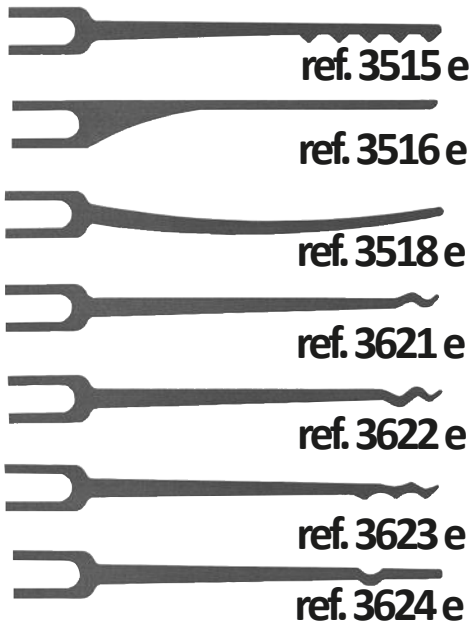

Novum handle for Picks ref. 3640

Handle for pick blades
"Novum" and "Car"



Pick Gun ref. rgn-225

The Pick Gun is designed to easily rake open pin and disc tumbler locks. Rapid squeezing of the trigger bounces the pick needle, raising the pins or discs to the shear line. All you add is proper tension, and the lock is open.

Optional Rakers
ref. 00287
ref. 00288
ref. 00289



Pick Gun Holster ref. rgn-226

Special design for locksmith to carry pick gun conveniently. It can be worn on the belt very easily. As you need to use pick gun, this holster is very simply to be opened.



Pin&Disk Tumbler Lock Picks Set ref. 10085

New Pin&Disk Tumbler Lock Picks Set. Designed to unlock Pin&Disk Tumbler Cylinders set in difficult spots.

o 17 Pick
o Rubber case included



Draw and cabinet jiggle blank set "Standard" ref. PC 801



For use with antique and modern 3 & 4 lever cabinet locks. This set comes with 15 double ended tools making up to 30 varieties.

oMade from Stainless Steel and complete with roll up material case.

Bit height: 6.5 mm
Diameter shaft: 6 mm
Diameter hollow shaft: up to 4.5 mm
Total length: 75 mm
Shaft length: 42 mm
Each shaft with 2 different tips

Draw and cabinet jiggle blank set "Mini" ref. PC 802



For use with antique and modern 3 & 4 lever cabinet locks. This set comes with 15 double ended tools making up to 30 varieties.

oMade from Stainless Steel and complete with roll up material case.

Bit height: 4.5 mm
Diameter shaft: 6 mm
Diameter hollow shaft: up to 4.0 mm
Total length: 75 mm
Shaft length: 42 mm
Each shaft with 2 different tips

Special Pick Set Micro Jigglers

ref. 00325

A set of 6 very small Jiggler Keys to help open smaller wafer locks. Ideal for desk locks, cabinets, attache cases, luggage cases, etc. Combines the tension tool and hand pick, thereby speeding up and aiding opening technique

Mini Jigglers

ref. 00326

A set of 6 smaller jiggler keys to help open different car locks as well as Petrol Locking caps, Lockers, Cam Locks, Padlocks, Showcases and numerous other locking devices. Works on both pin tumbler and wafer mechanisms. Combines the tension tool and pick, therefore speeding up and aiding opening techniques.



Extractor Set 2000

ref. 00307

The Extractor Set is the ultimate in broken key and pick removal. The tools are designed to slide next to broken keys along the side mill and ride along the bottom pins to hook into a cut in the key. The tools are made of high grade stainless steel and can be bent to reach around many obstacles.

- o Shirt Pocket Size (Closed): 1-3/4" x 5-5/8" (4.5 x 14.5 cm)
- o Genuine Leather Case with Snap
- o Contains 4 Extractors. Stainless Steel Components

Extractors (spare parts)

ref. 3460E

SSX-10, 0,5 mm



ref. 3461E

SSX-11, 0,5 mm



ref. 3462E

SSX-20, 0,5 mm



ref. 3463E

SSX-21, 0,5 mm



Interchangeable Extractor Set ref. 00315

It includes 4 extractor blades stored inside a hollow handle.
Shirt Pocket Size (Closed): 1/4" x 3-1/2" (0.65 x 9 cm)
Contains 4 Interchangeable Extractor Blades

Spare Parts

ref. 00316

EZ-7A, 10saw type extractor blade

ref. 00318

EZ-7C, 10 round extractor (.050" / 1.27 mm Ø)

ref. 00317

EZ-7B, 10 round extractors (.040" / 1 mm Ø)

ref. 00319

EZ-7D, 4 (ref. 00316), 4 (ref. 00317), 2 (ref. 00318)



Extractor Kit "PEK-Big"

ref. 3295p

- Sure-Grip Rubber Handles

The kit comes in a full grain cowhide bi-fold case and contains the blue series pliers type double sided key extractor set, a set of three single sided extractors, two sidewinder extractors that slip along the side of a key, and a miniature saw blade extractor made just for this set.



Sidewinder Extractor Set

ref.p ss-ext

The original Sidewinder Shim Extractor provided a powerful method of sliding in alongside a broken key and catching the tip of it with the bendable sharp tip as you draw the extractor back out.



Broken Keys Extractors

ref. 00384 EZ-1, 0,6 mm

ref. 00385 EZ-5, 1,0 mm

ref. 3446E EZ-2, 0,6 mm

ref. 00387 EZ-3, 0,6 mm

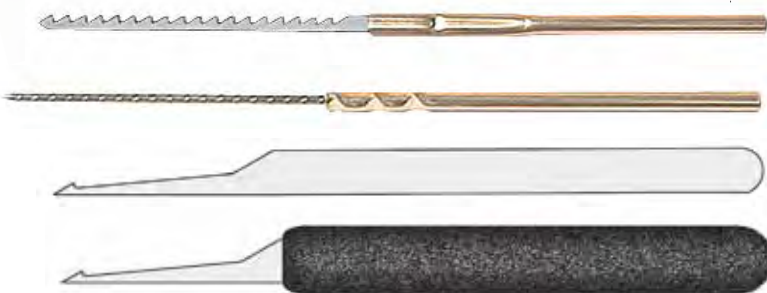

Feeler

ref. 00401

FEE-1, 0,6mm



Pick Grip Handle

ref. 00349

- o 5 soft foam pick grips for picks with or without metal handles
- o Its unique design grips tools without any adhesive
- o 3/16" (4.75 mm) round

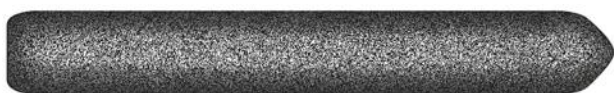

Broken Drill Bit Extractor ref. p bdb-e

This innovative tool is three layers thick.
Reaches approximately 1.5".
Works on bits form 3/16 to 1/2"



ref. p ldb-e

This innovative tool is three layers thick.
Suitable for difficult extractions in safes,
etc.



3 Piece Extractor Set ref. p 3pe-b

This 3 piece set offering of high quality extractors
is ready to add to your pick set arsenal, or for
replenishing your ref. 3295p extractor kit.
Packaged in a re-useable tube at a low price!



The best in extraction!

2 Piece Extractor Set ref. p 2p-se

More than one pick set? This set gives you two of our
saw toothed extractors in blue spring steel at one great
price.



The best in extraction!

Mini Knife ref. 00327a



When a combination is lost or not available for a briefcase, this is the tool to open it in less than a minute. The same technique can also be applied to the same style combination padlocks and even GM combination glove box locks. When you open the lock with this tool you also obtain the correct combination.

Briefcase Locks Include: Presto

Combination Locks Include: Sesamee, Presto, Master 175



Mini Knife for padlocks ref. p-knife

When a combination is lost or not available for a briefcase, this is the tool to open it. The same technique can also be applied to the same style combination padlocks and even combination glove box locks.

Extraction Pliers Set ref. p ess-b

This 3 piece extractor pliers set contains one of each of our extractor pliers in a calf skin snap over case.

optional

ref. **SAW-LBT**
Saw Blade Left

ref. **SAW-RBT**
Saw Blade Right

ref. **ICE-1BT**
Ice Tong Extractor Pliers



Mini Knife Value Pack Set ref. p pm-knife-3.

This three-piece set of Mini-knife Tools is packaged in a re-useable plastic tube with complete instructions. Leather case not included



Picks and Extractors

Stainless Steel Handle with Stainless Steel Tip

Tip thickness 0,5 mm

ref.

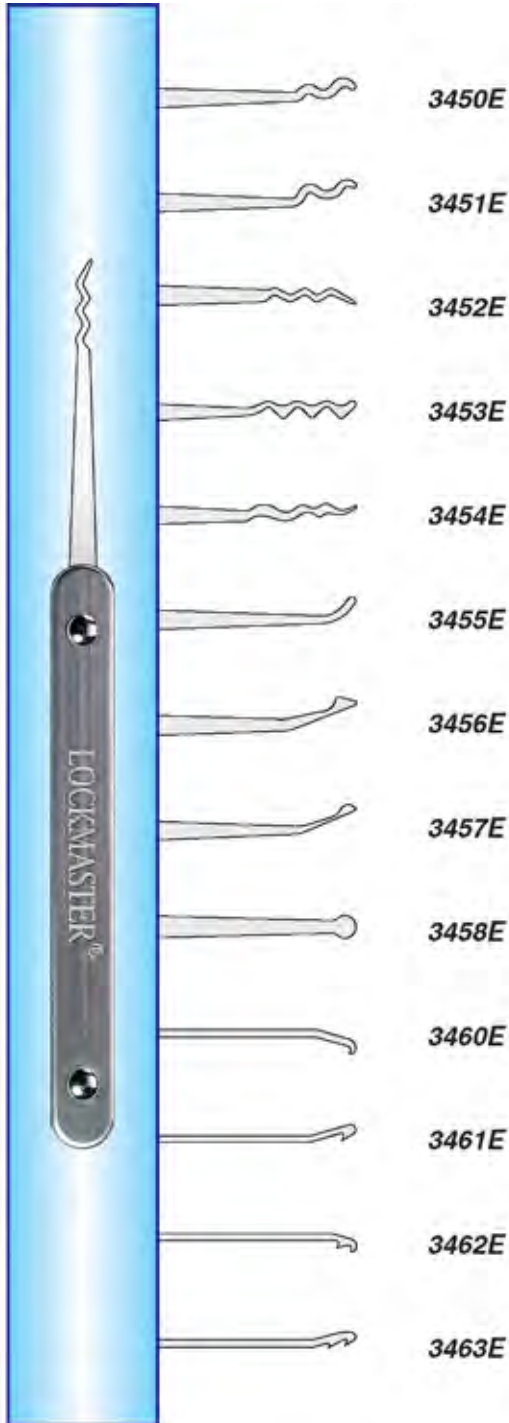

Tip thickness 0,6 mm

ref.

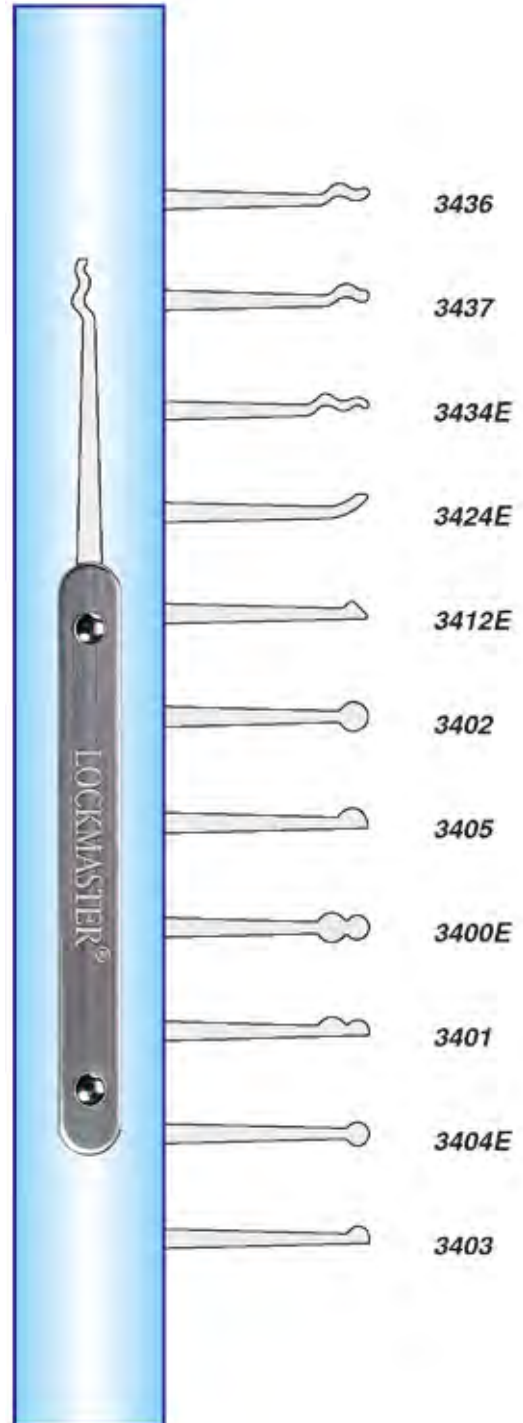

Picks and Extractors

Stainless Steel Handle with Stainless Steel Tip

Tip thickness 0,6 mm

ref.

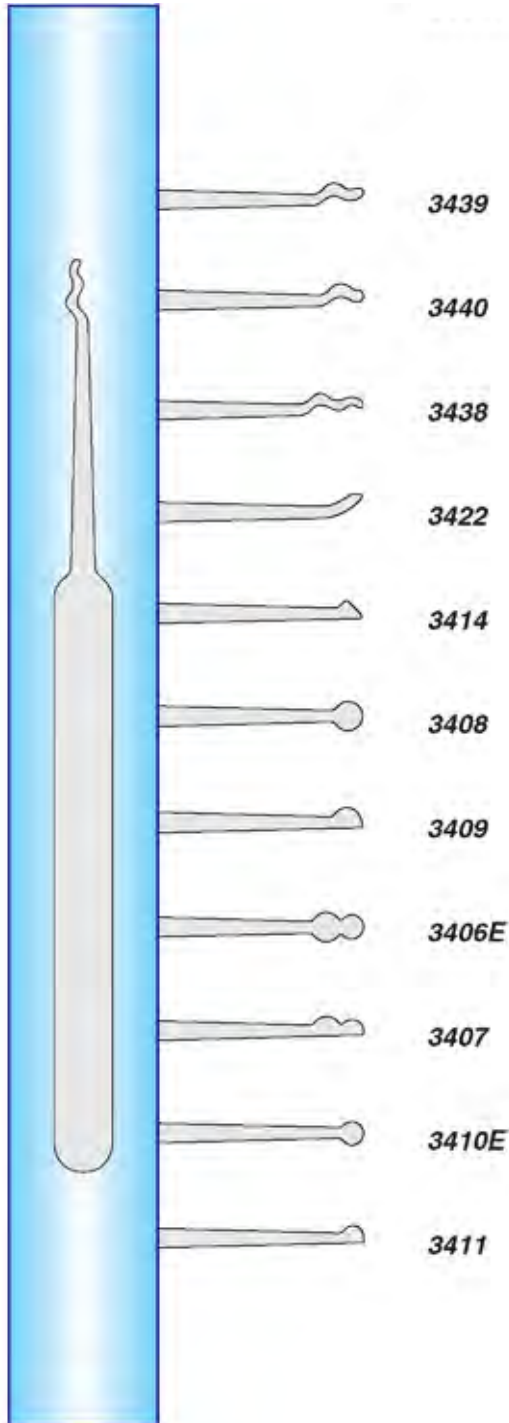

Tip thickness 0,7 mm

ref.

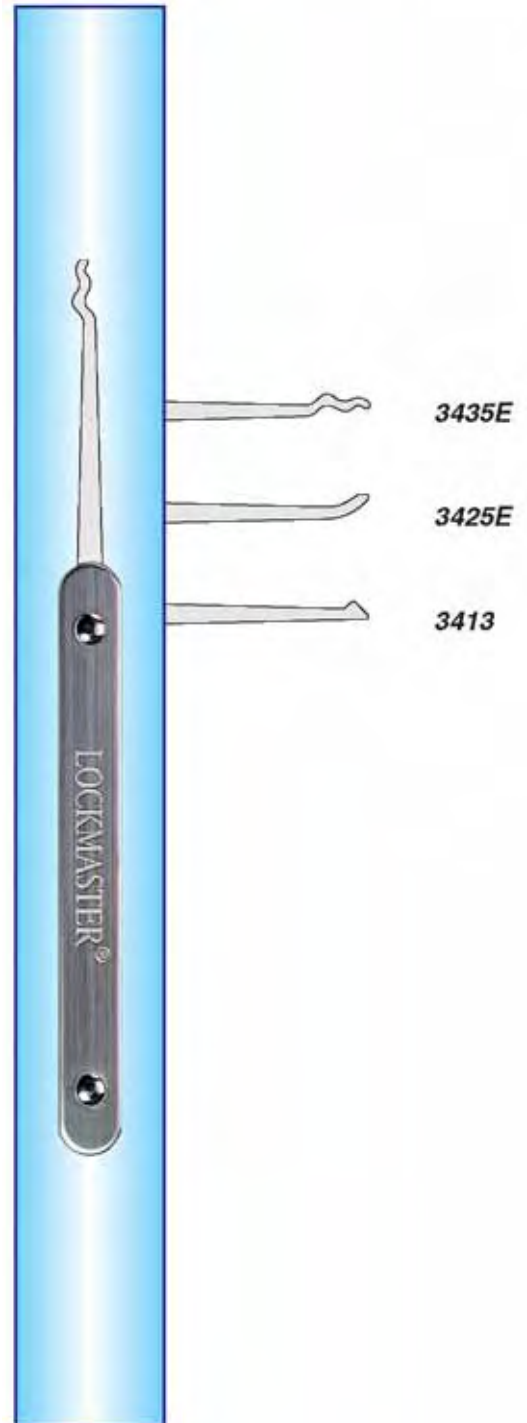

Picks and Extractors

Stainless Steel Handle with Stainless Steel Tip
Available in 0,6 mm. and 0,9 mm.

Special shapes

ref.

Tip thickness 0,5 mm

ref. 3459E

ref. 3465E

ref. 3466E

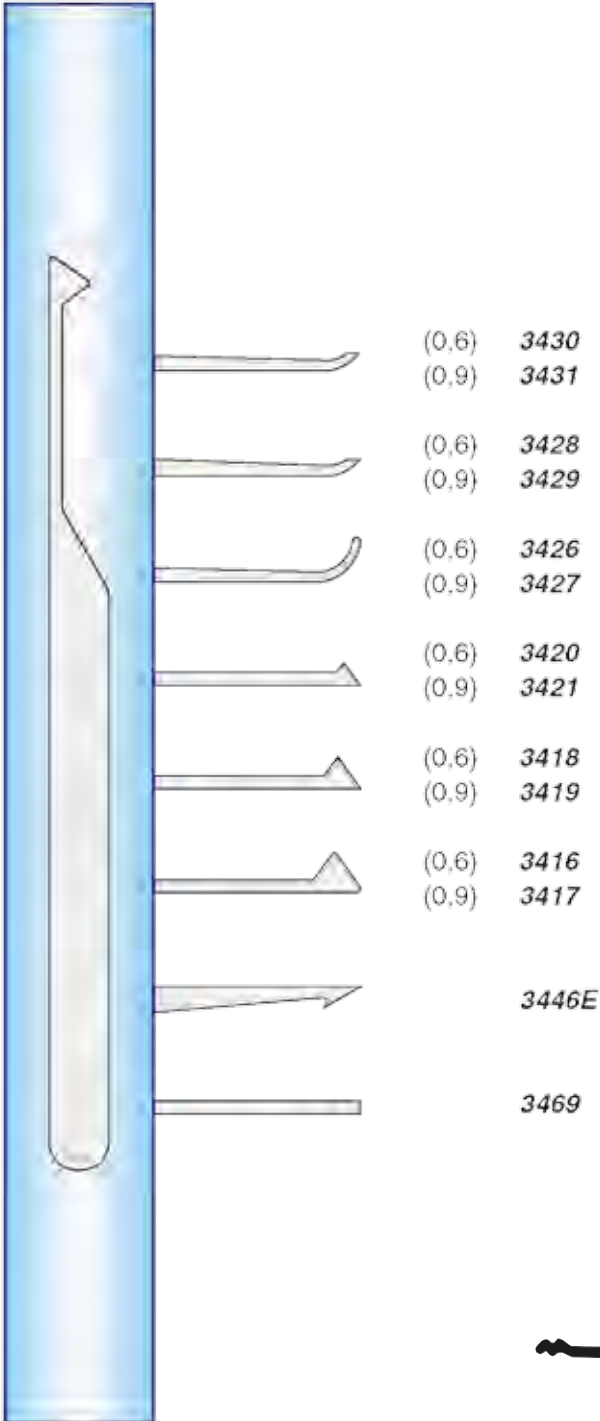

Tip thickness 0,6 mm
ref. 3443



ref. 3442E



Tension Wrench Low



ref. 00241	TR-9	13,35 cm
ref. 00242	TR-12	11,45 cm
ref. 00243	TR-8	10,15 cm
ref. 00244	TR-7	8,25 cm
ref. 00245	TR-11	8,25 cm

Medium



ref. 00246	TR-25	13,35 cm
ref. 00247	TR-14	11,45 cm
ref. 00248	TR-24	10,15 cm
ref. 00249	TR-23	8,25 cm
ref. 00250	TR-13	8,25 cm

High

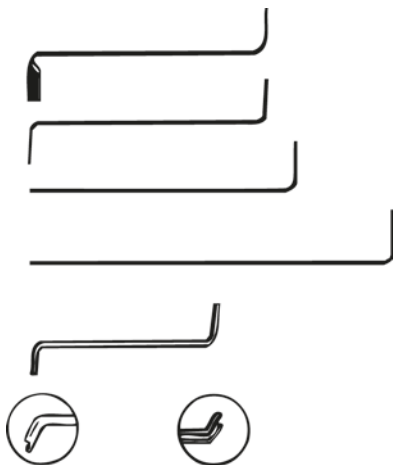

ref. 00251	TR-4	5,70 cm
ref. 00252	TR-3	5,70 cm
ref. 00253	TR-5	7,00 cm
ref. 00254	TR-6	9,50 cm
ref. 00255	VV-6	5,08 cm

Torque & Tension Tool TNT-20 ref. 00291

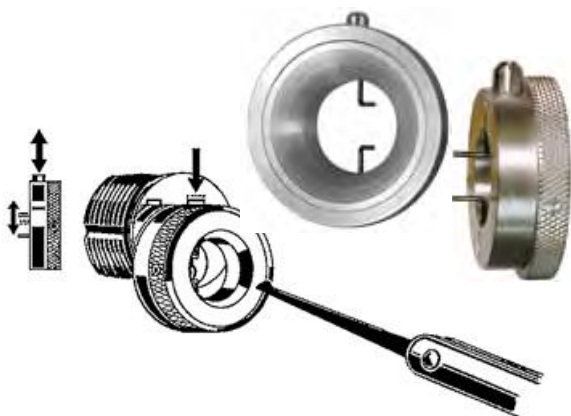

Incorporates spring loaded adjustable prong with other spring-controlled tension. Incorrect tension is one of the most common causes of picking failure. Use of this tool provides an easy method to apply the correct amount of tension every time. We highly recommend its use with electro pick ref. 00270.

This tool replaces a variety of tension tools in picking. It is smaller, feather weight and can be adjusted universal to the size of the keyway by the dual prongs.

Tension Wrench



ref. 00259 STW-4



ref. 00258 STW-3

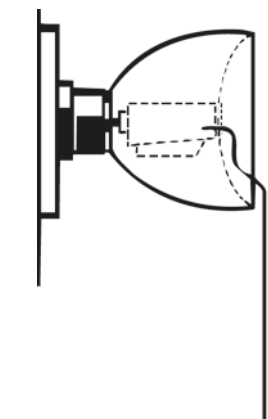

ref. 00256 TR-22

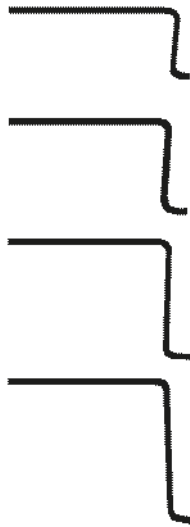

ref. 00260
TEN-2 1,9 cm

ref. 00261
TEN-3 2,5 cm

ref. 00262
TEN-4 3,2 cm

ref. 00263
TEN-5 3,8 cm



ref. 00266 Ten-9 High Tension



ref. 00267 Ten-7 Medium Tension



ref. 00257 TR-2

Alternative Tool for unlocking door locks

ref. bypass ISEO

Alternative tool for unlocking door locks when there is an ISEO cylinder with knob inside.

Without Damage.

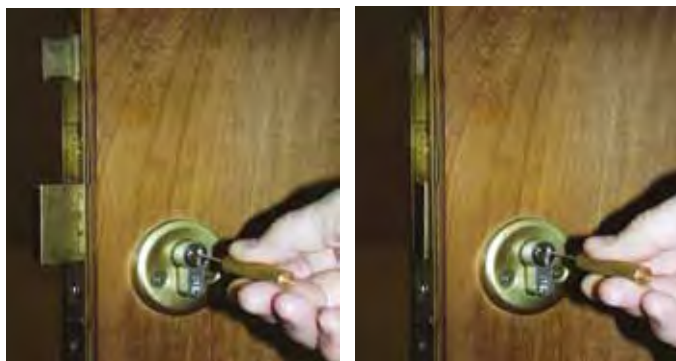

ref. bypass TESA

Alternative tool for unlocking door locks when there is a TESA lock with knob with outside key.

Without Damage.

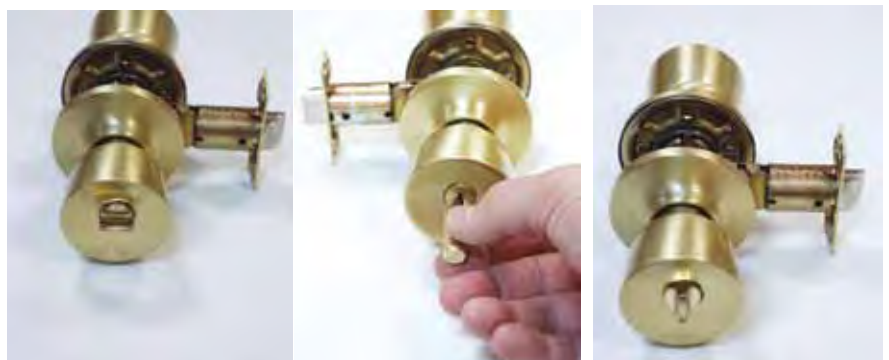



Spyhole Dismantling Pliers ref. 00219a

Pliers designed to turn off door spyholes



Drill Aid ref. R 1087E

Drill aid to be used to unscrew door eye-hole.



New!



Door Handle Tool "Lock Off" ref. 00219

Opening of a closed door takes place with this tool through the existing or new drilled hole of the door spy. Many times the only possibility of a professional opening.



Bump Key Technique: Tomahawk Hammer

ref. 3100

The so called Bump Key Technology enables everyone the opening of standard lock cylinders in door locks. The lock is not damaged in the process.



weight: 54 g
length: 207 mm

Bump Key Technique: Key Set

ref. 99

Bumping Key Set

High Security Keys

T80
T60
MEGA6
CS/5
CVL-9D
IS-6D
MCM 16 E8
EZ S-10E
LIN-21D ó 19D

EZ DS-15R (5 pitones)
EZ DS-15R (6 pitones)
STS
MINI X6
STS MINI X5
UCEM 8D
AZBE HS6 ó AZ-14
STS TV5.

Standard Keys

LIN-15I
LIN-15D
FAC-13D
MCM-4I
MCM-4D
AZ-18D
TE-8I
ISEO

CVL-5D
CVL-5I
CI-DL
LIN-3D
LIN-3I
MCM-13D
MCM-5D
MCM-5I

Call up to know the latest prepared keys!!

New!





Hydraulic Door Lifter ref. 6665

Powerful Hydraulic Door Lifter

New!



Door Lifter ref. 6650

Useful Door Lifter

New!



Vertipress ref. 6655

Useful Door holder

New!



Multifunctional Key

ref. 1066

Many craftsmen, service technicians and authorities cannot do without this key!

- o Policemen and Fire Fighters
- o Locksmiths
- o Heating engineers
- o Electricians
- o Joiners
- o Caretakers
- o Facility Management

o Zinc-Die Cast with nickel-plated surface.



Keys for profile cylinders

ref. 00217A

Metal Key. Various Square Pin Lock Key; size 6, 7 and 8 mm.
Scale to measure profil cylinder lengths.
Conic Square Drive 6-10 mm.
Hegagonal Spanner, top 3 mm
Zinc-Die Cast with high polished nickel-plated surface.



ref. 00217

Metal Key. Various Square Pin Lock Key; size 6, 7 and 8 mm.
Scale to measure profil cylinder lengths.
Zinc-Die Cast with high polished nickel-plated surface.



ref. 00212

Plastic Key. Scale to measure profil cylinder lengths.

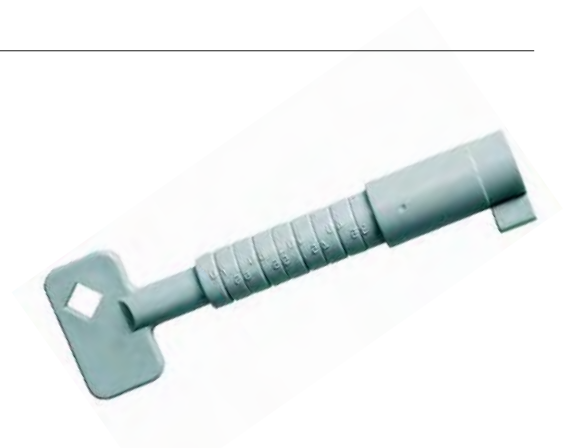

Abloy Pick for Russian Locks ref. 0690 RU

Special pick for russian locks



Decoder "SPUTNIK" Decoder "SPUTNIK" model ABUS ref. 3570

Decoder for Abus AU 20 profile



We can prepare the decoder you need for the key you choose. Call up!

Decoder "SPUTNIK" model CES ref. 3571

Decoder for CES

Ring Magnet for Electronic Manipulation ref. MAGNET-RING

Allows the manipulation of electronic locks and systems.



Tubular Decoders

This precision Tubular Pick was developed in our company. Tubular locks out of European production made it necessary that the individual feelers can be adjusted after the respective demands and that the feelers can be fixed. All of them are in a 70x200x30mm box

AGA 7 pins ref. 00459

- o for locks "AGA"
- o 7 Pins
- o 10 mm Ø



Meroni ref. 00460

- o for locks "MERONI"
- o 7 Pins
- o 19 mm Ø



Gile ref. 00473

- o for locks "GILE" (roller shutter type)



Tubular Decoders

This precision Tubular Pick was developed in our company. Tubular locks out of European production made it necessary that the individual feelers can be adjusted after the respective demands and that the feelers can be fixed. All of them are in a 70x200x30mm box



AGA 8 pins

ref. 00461

- o for locks "AGA"
- o 8 Pins
- o 12 mm Ø



LYF

ref. 00462

- o for locks "LYF"
- o 7 Pins
- o 19 mm Ø



Tubular

ref. 00463

- o 6 Pins
- o 19 mm Ø



Tubular New

ref. 00463a

- o 6 Pins
- o 19 mm Ø



Tubular Decoders

This precision Tubular Pick was developed in our company. Tubular locks out of European production made it necessary that the individual feelers can be adjusted after the respective demands and that the feelers can be fixed. All of them are in a 70x200x30mm box

Stark/ Keymat/ Bilma

ref. 00464

o for locks "STARK", "KEYMAT", "BILMA"
o 7 Pins
o 19 mm Ø

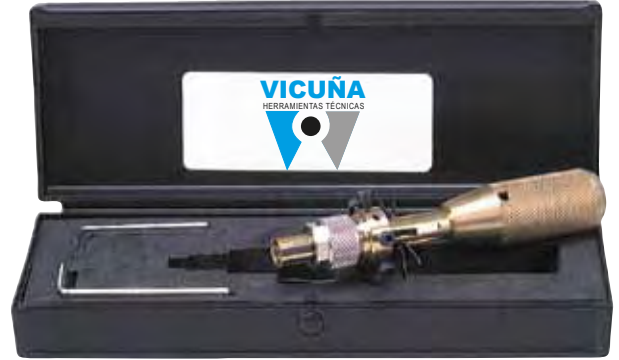

Serraller

ref. 00465

o for locks "SERRALLER"
o 6 Pins
o 19 mm Ø



Serraller Star

ref. 00472

o for locks "Serraller Star"
o 5 Pins
o 22 mm Ø



Sidese/ Fontaine

ref. 00466

o for locks "SIDESE", "FONTAINE"
o 5 Pins
o 19 mm Ø



Tubular Decoders

This precision Tubular Pick was developed in our company. Tubular locks out of European production made it necessary that the individual feelers can be adjusted after the respective demands and that the feelers can be fixed. All of them are in a 70x200x30mm box



Toy
ref. 00467
o for locks "TOY"
o 6 Pins
o 19 mm Ø



Laperche
ref. 00469
o for locks "LAPERCHE"
o 5 Pins
o 19 mm Ø

Decoder for cylinder of Round Inceca

ref. 00468bis



This precision Tubular Pick was developed in our company.
o Hand made precision tool
o Extreme easy handling
o for locks "INCECA"

Decoder for cylinder of Inceca

ref. 00468



This precision Tubular Pick was developed in our company.
o Hand made precision tool
o Extreme easy handling
o for locks "INCECA"

Injection Pick I ref. v/inj1

This tool has been designed for unlocking lever locks with 2 bolts.

Shutter locks. These locks are very difficult to be unlocked without damaging. It's also possible to manipulate a safe lever lock.



Some locks which can be opened with Injection Pick:

Its use is simple.

CR, MCM, LINCE, IDM, ET,
BTV (safe)...and else.

Injection Pick II ref. v/inj2

This tool has been designed for unlocking lever locks with 2 bolts.

Safe locks. These locks are very difficult to be unlocked without damaging. It's also possible to manipulate an apartment door lever lock.

For apartment door lever locks:
CISA, MCM, LINCE
and safe locks CISA ,ARREGUI...



Injection III Núcleo Compact ref. v/inj3

Tool especially designed for unlocking lever locks (Mottura) with interchangeable nucleus.

Unlocking Time: about 10 minutes
Possibility of getting the key
It includes 2 variable keys



New!

New Tool for Mul-T-Lock

New tool on the Latch-opening Mul-T-Lock. In a few minutes you can open this lock without causing any damage.



ref. mul-t-lock5l
Mul-t-Lock
5 pins Leftward.



ref. mul-t-lock5r
Mul-t-Lock
5 pins Rightward.



ref. mul-t-lock7r
Mul-t-Lock
7 pins .

Special Files for Impression Technique

ref. 00500	lima plain New!
ref. 00530	file grain 0 almond
ref. 00531	file grain 2 almond
ref. 00532	file grain 4 almond
ref. 00533bis	round file grain 0
ref. 00533s	round file grain 2
ref. 00533	round file grain 4



Clockwork Files for Impression Technique

ref. 00534	knife file
ref. 00535	square
ref. 00536	sharp plain
ref. 00537	parallel plain
ref. 00540	plain round "mouse tail"
ref. 00542	half cane

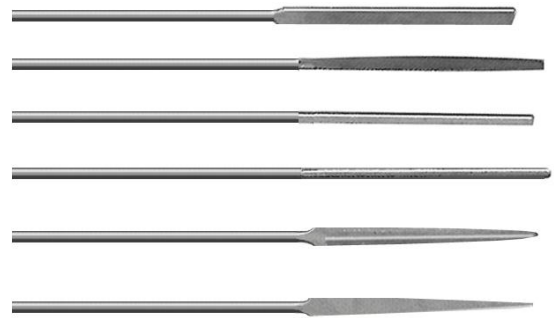

Impression Technique: Key Blank Holders

Grip specifically developed for the impression technique. Maintains a true centerline and grips the key so it can't slip.

Universal Key Blank Holder

ref. 00525

- o ergonomic grip
- o allows a strong connection with the key blank
- o for every kind of cylinders
- o steel and nylon made
- o Allen key included



New Universal Key Blank Holder

ref. imms001

- o automatic grip
- o no Allen key needed



Optical Impression Technique Instrument



ref. 00550

This simply to handle tool makes an extensive opinion of the key possible and allows among others to decide the spatial dimensionses, the depth of the cuts etc..All data are to be read off clearly on the scale.

Quadview Plus 2

ref. 00552

Whether you are impressing keys, inspecting lock parts or working on time lock movements, you'll appreciate the sharp, clear magnification and illuminating side lights on this product. In this model, the side lights and lens options are built-in and easily accessible.



Four levels of magnification (1.8 to 4.8) are built in:

- Magnification 1.8 - Lens 1
- Magnification 2.3 - Lens 1+2
- Magnification 3.7 - Lens 1+3
- Magnification 4.8 - Lens 1+2+3

The Quadview Plus 2 is lightweight in design with an adjustable velcro headband. You can work for hours without discomfort.



Scope for I/T

ref. 00550c

This new scope with 2x lights in different colours lets you see the marks in the key when Impression technique or bright are applied.

Mini Drill For Impression Technique

ref. 28515

Drill/Burr for Impression Technique.
It includes 34 tools.
Source Power
220/240V



CLAM™ Kits Large Clam Kit "LKM 1178"

ref. 00555

Designed to give an exact image of a key, the Clam allows the user to conveniently cast a replica key. Duplicates of rare and historic keys may be created by utilizing the Clam. The duplicates can be cut at a later date or different location. Duplicates of the bit on a high security key can be cast and preserved for later duplication resulting in considerable savings for the customer and a high margin sale for the safe technician.



CLAM™ Kits De Luxe Clam Kit "LKM 1187"

ref. 3848

Designed to give an exact image of a key, the Clam allows the user to conveniently cast a replica key. Duplicates of rare and historic keys may be created by utilizing the Clam. The duplicates can be cut at a later date or different location. Duplicates of the bit on a high security key can be cast and preserved for later duplication resulting in considerable savings for the customer and a high margin sale for the safe technician.



Quick Key ref. 00555a

This key-duplication system consists of high-tech plastic molding components and a special cast alloy (cast metal). The system satisfies even the highest requirements and allows the absolutely precise, fast and easy duplication of keys of any type of locking mechanism.



Box Set to make keys

Box to make keys manufactured in PVC in order to get samples of keys.

ref. 00544

small size

ref. 00543

large size

ref. 00546

special plasticine





Mini Lighter ref. 00792

Ideal for releasing locks when glue or silicone is inside. You can charge it like a normal lighter.



Special File ref. 9565701

350 mm Special File.
Suitable for keys prepared for
Impression Technique



Cross Picks ref. 00470

This manual picking tool allows the opening of simple cross
locks.
o for Yale, Fiam, etc.



ref. 10019

This is A-Grade Cross Pick which is different with most cross
picks on the market. It's four direction bades are made of
quality strong carbon steel blade different with steel wire
(easy to break).

It can insert into cross cylinder to open very smoothly.
This A-Grade Cross Pick includes 2 tension wrenches: one long
tension wrench, one short tension wrench to fit for different
size of cross cylinder and different size of thickness of door.



ref. T 00470

An extraordinary new Cross Pick.

new!



Decoder for padlock ref. 00780

The high-precision tool for Abus Granit disc locks. Using this
tool is relatively simple thanks to its easily readable depth
scale. Still, in order to be successful some practice is required.
Length: approx. 110 mm
Weight: approx. 120 g

Ring Pliers

ref. 00604

New pliers designed to close cylinder rings.

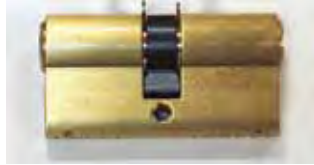

Clip Opener

ref. crt 2

This tool is ideal to turn off the clips inside the cylinders



Convertible Truarc Ring Pliers

ref. 00603

The Convertible Truarc Ring Pliers can quickly and easily convert from ring compressor (external) to ring spreader (internal).

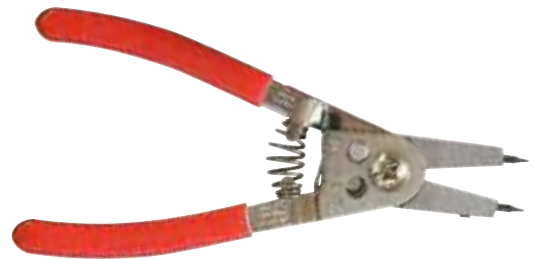

Shim-Holder Tools

ref. 10072

Dismantle cylinders Set

New case.

new!





SHUT-22 ref. 00602

The Adjustable Follower does it all. The spring action bar allows the tool to fit all standard locks.



Shims ref. 00596

Shims to dismantle cylinders inside.



Shim-Holder ref. 00595

This tool holds curved shims without slipping. Also helps prevent cut fingers. To loosen, simply tap the end on a hard surface. Then, insert the shim and refit to desired length.



CVL,UCEM,AZBE,CISA,UNION,
YALE,WEISER

We can supply you pins for
re-pinning different cylinders

Pins Box for re-pinning cylinders ref. 00951

It includes:
144 pins of each measure
85 different measures diferentes
Pins anti-pick
Measure increasing 0,5 mm
All the pins coloured
Metal box
8 Kgs.



New!

Pin Box ISEO ref. I00300

ISEO pin box to master ISEO cylinders.



New!

Pin Box Tesa ref. 01000

ISEO pin box to master TESA cylinders.

Tool for New Mottura

ref. 5705

High-quality pump cylinders of "Mottura" can be decoded and unlocked destruction-free with this new accuracy tool.



Pump Lock Decoder

ref. dmottura

Pump Lock Decoder set.
Auto Impression tool to
unlock pump locks in 3-5
minutes.



For Mottura and Potent Locks!

New!



Tool for New Iseo ref. 5706

Tool specially designed for opening and decoding ISEO lock.

Comes in an approved plastic carrying case with foam-lined interior



New Tool for Unlocking GERDA lock ref. GERDA LOCK

A new tool for unlocking and decoding the pump lock GERDA.



Foil Tool ref. 0710

11 pieces Double-suite can technically open European Locks of: BASI, BKS, CVL, DOM, EZCURRA, DS 15, FAC, ISEO, LINCE, MCM, MUL-T-LOCK, TESA T60, UCEM, WILKA and other locks like crescent-type buyang, AFA, double-nine, Murray Bulgaria, Vanguard, Coradi double beads, ho di, Dunfa, Jia Wie, Paul Dean, Aipu, single beads, with the new and old Gabriel, Buttonyang, Europe and United States Lun double bead AB Kabbah lock.



Door Handle Opener for Double Bitted Key Systems

ref. 00427

The tool makes possible to open a door through the keyhole of a lever mortice lock with double bitted key.

- o only for systems with double bitted keys
- o for locks of CISA, Mottura, FAC, CR, Juwel, Ezcurra, etc.



Knee Pad Safe Technician

ref. 4729

When was the last time you went to open a safe and you did not have to get down on your knees, usually on concrete, to do part of the safe opening. This foam knee pad has Safe Technician imprinted on it and takes the pain out of being on your knees.



Morticer Jig ref. 01006a

The best value mortice jig available. Cuts a mortice in all wooden & aluminium doors. The jig and its precision cutters will cut a mortise in hardwood, softwood, composite doors and with the use of special cutters, aluminium doors as well, all in under five minutes. For best results use a drill with 2-3000 rpm with "Hammer Action" off and 12.7 mm (1/2") chuck. Maximum Mortice depth: Standard Shaft 90 mm (3.5") and optional Long Shaft 154 mm (6")



Further Available accesories:

Ref.	cutters
01008	wooden, 16 mm
01009	wooden, 17,5 mm
01011	wooden, 20,6 mm
01013	wooden, 23,8 mm
01015	wooden, 27 mm
01016	wooden, 31,8 mm
01010	wooden, 19,0 mm
01012	wooden, 22,2 mm
01014	wooden, 25,4 mm
01017	aluminium, 19 mm
01018	aluminium, 25,4 mm
01019	aluminium, 31,8 mm

The delivery also contains:

Wood Cutter, 19 mm (3/4") Ø
Wood Cutter, 22.2 mm (7/8") Ø
Wood Cutter, 25.4 mm (1") Ø

Long Drill Kit

Available in 2 measures:

ref. DBB/HK/LD 10950
ref. DBB/HK/LD 101250

10 mm x 950 mm
10 mm x 1250 mm



Long Drill Adaptor for Lock Jig

ref. DBB/LD/A



Decoder for door fittings with magnetic function ref. magnet-dec

Decoder for door fittings with magnetic function, e.g. DiSec etc.

Two adjustable magnetic fields make the manipulation of magnet fittings possible.



Broken Drill Bit Un-Winders ref. p bdb-uw

Turn that broken bit loose! A metal chip strong enough to break a drill bit can make getting the tip un-jammed a tough job. Our set of 4 spring steel tools gives you the reverse force needed to free a wedged bit. Just a twist of the wrist, or LIGHT tap of a hammer, gets that stubborn tip loose and ready to remove with our Broken Drill Bit Extractors. Designed for 3/16 and 1/4 inch drill bits.



Tilting Window Opener ref. 00609

Three-part set to open tilted windows over the inside window handle. So easy to use



Place the handle over the Windows



Open the window with the guide wire



Get out the guide wire



Pull out the Windows

Safe Repair Kit ref. 04446

Drill holes can be locked durable with the materials contained in the Kit.

The Kit comes with:
o five different kinds of conic tapered steel pens
o four different kinds hard metal balls and
o one hard metal drill



Opener for Panic Doors ref. 1078 v

In most cases, this tool enables an opening of unlocked doors, that are to be opened to the outside. With this door latch retractor the latch can be pushed back. Suitable only for normal-offset doors.



Demo for Picking ref. maqueta

Demo Lock for picking

New!



Demo for Testing with Safe Locks ref. soporte

Demo Lock for testing with Safe locks

New!



Key Cutting Machines ref. capri



CAPRI is the new JMA key cutting machine for security, wave, tubular and special keys, designed for key-cutting professionals. The CAPRI key-cutting machine is a striking step forward compared to other manual key-cutting machines, as it incorporates a novel patented system for measuring the cutting force, making cutting easy and precise

new!

Technical features
Motor: Universal 220V, 50Hz, 400W, 16000 rpm.
-430 x 465 x 385 ; 25kg.

ref. saratoga



MIXED machine with 2 units:
1. Cutting of flat keys (cylinder lock and car) and cross-shaped keys, with a reversible 4-side clamp and a micrometric tracer point with centesimal adjustment.
2. Cutting of mortise lock keys (single and double blade), front keys and special keys like ref FO-4.P and FO-6.P keys. It also has 3 optional slides for cutting regata keys (RG)(SEA, OPEL, MERCEDES), for code copying of FO- 6.P (FT-COD) keys and also a slide for Abloy keys (ABL).

MOTOR
220V-50Hz
INFORMATION
590 x 260 x 470; 43 Kg

New Tools for grasping small objects

Alligator & Kelly forceps are surgical instruments used for grasping small objects or removing items from small cavities in the body.

ref. KELLY FORCEPS 14CM
ref. KELLY FORCEPS 16CM
ref. KELLY FORCEPS 18CM

ref. ALLIGATOR FORCEPS 9CM
ref. ALLIGATOR FORCEPS 14CM
ref. ALLIGATOR FORCEPS 16CM



new!



Key Checker

ref. 00813

Use Keycheck when training on key blank identifications. It forms and holds the keyway on any sample key and allows you to match the right blank every time. o long searching after the right blank belongs to the past

The blank that fits into the key checker adjusted to the original key, can also introduced in the keyway of the lock.



Safe Key Gauge

ref. 00814

This gauge is an useful help to make safe keys.

o simply and precisely adjustable



Proxxon Grinding & Polishing Machine

ref. r 2228030

The slim housing facilitates the grinding of long workpieces and includes an adapter to connect a vacuum cleaner to the unit. The tool rests and eye guards are both adjustable.

Variable speed of 3,000 - 9,000 rpm with standard wheels.

Motor 220/240V.

Weight approx. 1.2kg

Size 250 x 130 x 100mm.

ref. 28308

A corundum disc

ref. 28310

A silicon carbide disc



Vise Proxxon

ref. 00529

To clamp tools and keys - specifically made for the mobile use.

o adjustable into all directions

o with suction cup



Vise Universal

ref. 00607b

To clamp tools and keys - specifically made for the mobile use.

o adjustable into all directions

o with suction cup



Endoscopes Ø 4/4.5mm

- 4mm shaft goes through small openings.
- Fiber Optic Endoscopes. No danger of ignition in cavities through bulb implosion. Immersible in approved fluids (water and oil), no lens fogging. Temperature-rated to 120° Celsius. No heat generation at the tip of the instrument.
 - Angle of view: 40°.
- Complete overview: 0° viewing direction. Viewing direction with mirror tubes 70°, 90° or 120°. Rotate mirror tubes for a 360° view.

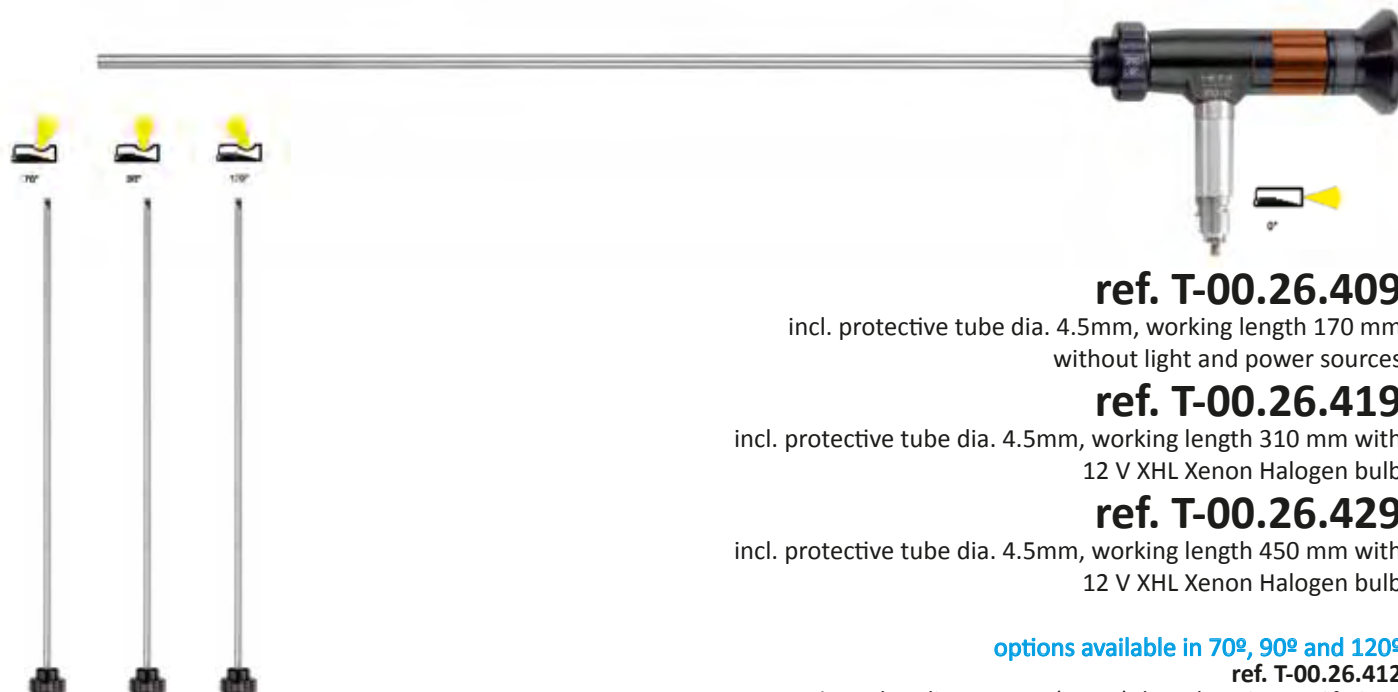

ref. T-00.26.409

incl. protective tube dia. 4.5mm, working length 170 mm
without light and power sources

ref. T-00.26.419

incl. protective tube dia. 4.5mm, working length 310 mm with
12 V XHL Xenon Halogen bulb

ref. T-00.26.429

incl. protective tube dia. 4.5mm, working length 450 mm with
12 V XHL Xenon Halogen bulb

options available in 70°, 90° and 120°

ref. T-00.26.412

Protective tube, dia. 4.5 mm (spare), length 170 mm, 0° view.
direction

ref. T-00.26.422

Protective tube, dia. 4.5 mm (spare), length 310mm, 0° view.
direction

ref. T-00.26.432

Protective tube, dia. 4.5 mm (spare), length 450mm, 0° view.
direction

Light- and power-sources:

3.5V-version:

BETA Battery handle with 3 dry batteries or rechargeable handles NiMH or Li-ion. AV-adaptor with XHL bulb or LED ScopeLight.

12V-version:

Connecting cable for cigarette lighter socket (5 m) or Accubox I with brightness control and Accubox II with on/off switch (AV-Adaptor required).

ref. T-554.28.123

Set incl. Protective tube, length 310mm LED ScopeLight, Mirror tubes 70° and 120°, Angled attachment 120/120, rubber eyepiece, BETA Battery handle, Extension cord automatic plug, transport and storage case

ref. T-555.28.123

Set incl. Protective tube length 450mm LED ScopeLight, Mirror tubes 70° and 120°, Angled attachment 120/120, rubber eyepiece, BETA Battery handle, Extension cord automatic plug, transport and storage case

ref. T-546.50.246

Set contents: Endoscope including protective tube, AV-adaptor incl. 12 V XHL Xenon Halogen spare bulb. Mirror tubes 70° and 120°, angled attachment 120°/120 mm, connecting cable for cigarette light socket, rubber eyepiece. 12 V XHL Xenon Halogen spare bulb, transport and storage case

ref. T-547.50.246

Set contents as T-546.50.246, however with Endoscope dia. 4.5/450mm working length



Rigid Endoscopes

8 mm. Ø Endoscopes

Robust. Independant from mains power supply. Exceptionally bright.

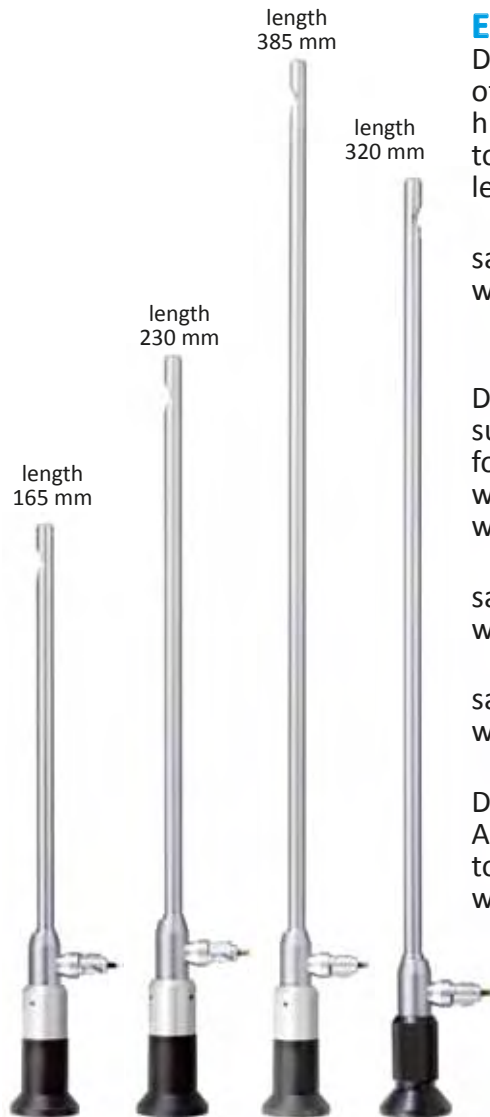

Endoscopes

Direction of view 90°, field of view 35°(focussable) for high magnification, with bulb, total length 330 mm, working length 230 mm

same, but with t.l. 485mm, w.l. 385mm

Direction of view 70°, super wide-angle (fixed focus) for large angle of view, with bulb, total length 270 mm, working length 165 mm

same, but with t.l. 335mm, w.l. 230mm

same, but with t.l. 490mm, w.l. 385mm

Direction of view 90°, Angle of view 56°, total length 420mm, working length 320mm

3.5 V

12 V

ref.T-02.26.103

ref.T-05.26.103

ref.T-02.26.102

ref.T-05.26.102

ref.T-02.26.123

ref.T-05.26.123

ref.T-02.26.124

ref.T-05.26.124

ref.T-02.26.125

ref.T-05.26.125

ref.T-05.26.112

ref.00140b

Endoscope, 12 V XHL, working length 165 mm, angled attachment 120°/120 mm, connecting-cord for cigarette lighter, spare bulb, transport and storage case

ref.00140

Only the case



Accessories for Endoscopes



ref. t-02.25.369
BETA battery handle for 3 alkali-manganese dry batteries LR14 (batteries not included)



ref. t-00.99.230
Extension cord automatic plug



ref. t-02.24.105
Keyhole loupe with 3.5 V bulb, without handle



ref. t-00.26.090
Angled Attachment, 120°/120 mm

ref. t-00.26.093
Angled Attachment, 120°/360 mm



ref. t-08.26.075
LED ScopeLight
LED Light
3,5 v Bulb Light



ref. t-00.31.201
A-Cam camera with processor (available systems:
PAL or NTSC, please specify when ordering)



ref. t-02.88.075
XHL Xenon Halogen spare bulb 3.5 V



ref. t-05.88.103
XHL Xenon Halogen spare bulb 12 V for 4 mm endoscope



ref. t-05.88.095
XHL Xenon Halogen spare bulb 12V for 6 mm endoscope



ref. t-05.88.092
XHL Xenon Halogen spare bulb 12V for 8 mm endoscope



ref. t-05.88.079
XHL Xenon Halogen spare bulb for 8 mm endoscope



ref. t-00.26.175
Rubber Cap for Spectacle Wearers



ref. t-05.99.629
Accubox I, 12 V with brightness control, incl.
battery and mains transformer, without
connecting cord

ref. t-04.99.641
Rechargeable battery NiMH

Smart Clamp

ref. R-Smartclamp

Universal endoscope adapter for mobile phone or smart phone handsets. Adjustable side clamps with neoprene pads

Max. handset 75 mm

For endoscope with an industry standard 32 mm eyepiece



Semi Flexible 4,5 mm. Ø Endoscopes

ref.10218

new!

Designed for up-close focusing in tight places, the high-resolution lens provides a clear image of objects as close as 19 mm (3/4") while providing a wide, 40° field of view.



Dial Puller

ref. LKM 1095

Removes Dials Quickly With Straight Line Reverse Thrust Produced By A Sliding Weight. Just center the cup over the dial, secure the allen screws and with just a few strokes the weight removes the dial. The Dial Puller works on any pressed-on or glued-on dials with minimum effort and damage.



Change Key Set

ref. 00050

The 12 Most Common Change Keys - A Must For Every Tool Box. Each key is individually labeled for easy identification and all are made of stainless steel for durability to prevent rusting.

Fits
Diebold 3-wheel & 4-wheel,
LaGard 3-wheel & 4-wheel,
Mosler 3-wheel & 4-wheel,
S&G 3-wheel,
S&G 4163,
AMSEC
Group 1R,
3-wheel padlock.

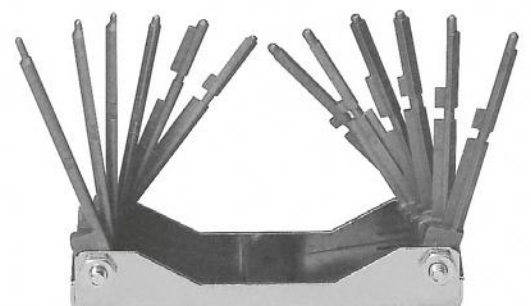

Steel Ball Hammer

Ref. 00121

This hammer has the power of a steel hammer because of its weight, and it has an advantage because it does not lose rebound power.

Suitable for disblocking safe devices, clocks, etc.



Ultrathermic Cutting System "HOT SHOT" Complete Kit ref. 00001.

This assembly consists of a torch, 15' of oxygen hose, a striker plate with a 15' power cable, two battery clamps, a leather shield for protection during piercing operations, and two collets for adapting either 1/4" or 3/8" rods to the torch.

In addition to this torch assembly, the "HOT SHOT" Complete Kit includes a back harness assembly, rod and striker plate holders, an oxygen cylinder (5 litre), a regulator, a battery ignition system (with charger), welding gloves, safety goggles and two Stix Paks of ultrathermic rods (9 rods 1/4" x 18" and 9 rods 3/8" x 18").

Broco's Ultra-thermic systems operate at temperatures exceeding 10,000 degrees F, eliminating the need for surface preheating.



- o Repairs are made without raising burrs on bearings and bushings because an electrical current is not required.
- o Broco's system does not leave carbon deposits eliminating the need for surface grinding and gouge cleaning.
- o Broco's Prime Cut systems are safer than other types of equipment because they do not require high amperage or potentially dangerous acetylene (or any other secondary fuel).
- o Prime Cut systems produce less noise, smoke and noxious gases than other systems increasing operator comfort and safety.
- o Prime Cut's user friendly features have been task engineered for simplicity of operation. The 12v DC ignition system, single oxygen fuel source with one regulator, and completely self-contained portable kits ensure that Prime Cut systems are easy to operate even for less experienced users

Ultrathermic Cutting System "HOT SHOT" Kit ref. 00002

The finest exothermic equipment for military and law enforcement breaching applications. In service by the best special forces, counter-terrorist and law enforcement groups worldwide.

From portable lightweight systems to custom heavy duty field equipment, Broco constructs torch kits to meet the needs of specialized applications. Broco torch sets are now carried on-board the U.S. Marine Corps' M88A2 Tank Recovery Vehicle and the Army's Forward Recovery System Heavy (FRS-H). Since 1985, specialists within the U.S. Army have extolled the benefits of exothermic torch systems for recovery applications. The Armor Center at Fort Knox recommended the removal of oxy-acetylene torches from recovery vehicles and replacing them with portable exothermic cutting units (PECUs). An exothermic torch can be fielded quickly, with minimum setup, no adjustment, and no preheating. A wider range of materials including exotic alloys and armor plate are easily cut. Thick sections like road arms and other suspension components can be severed in about a minute.

The kit contains:

Torch, striker plate, 20' of oxygen hose, 20' of power cables, two battery clamps, leather shield for protection during piercing operations, and collets to fit 3/16", 1/4", 3/8" and 1/2" rods.

It includes also a tool box, welding gloves, goggles and two sample packets of Ultrathermic cutting rods (9 rods 1/4" x 18" and 9 rods 3/8" x 18")



Rod Extender

ref. 00003

A 1 meter assembly that increases the torch reach.



Ultrathermic Cutting System Rods

Rod 1/4" x 18"

ref. 00007

Burn time: 35 sec

Main uses: cutting steel to 5/8" thick, removing large bolts, small pins, piercing hard plate

Rod 3/8" x 18"

ref. 00008

The most widely used rod size. Cutting cast iron to 1.5" thick.

Removing welds

Burn time: 45-50 sec

Main uses: cutting steel to 3" thick, removing pins to 8" long

Rod 3/8" x 36"

ref. 00009

Removing pins 8"+ long, cutting aluminum, melting concrete, cutting cast iron to 2.5" thick.

Burn time: 1 min 30 sec

Main uses: cutting steel plate to 3" thick, cutting steel shafts to 6" dia.,

Rod 1/2" x 48"

ref. 00010

Cutting shafts to 12" dia.

Burn time: 2 min 30 sec

Main uses: cutting steel to 6" thick, cutting cast iron to 4" thick

Rod 3/16" x 18"

ref. 00011

Burn time: 30-35 sec

Main uses: removing broken bolts, cutting locks, covers, hasps



Ultrathermic Cutting System Accessories

Torch Head Assembly, 15' Cable

ref.4302

Handle Assembly

ref.4301



Ultrathermic Cutting System Accessories

Collet Nut

ref. 4303



Battery Clamp (black)

ref.4306

Battery Clamp (red)

ref. 4307



Control Valve

ref. 4305



Collet Kit, Collet and Washer

ref. 4309

ref. 4310

ref. 4311

ref. 4317



Ø 6,35 mm

Ø 9,53 mm

Ø 4,76 mm

Ø 12,7 mm

Control Valve Lever Assembly

ref. 4316



Compression Washer

ref.4304



Flash Arrestor Screen

ref. 4313



Coupler Assembly

ref.4314



Flash Arrestor

ref.4312



Oxygen Regulator

ref. 4416

Striker Plate Assembly

ref.4315



All components fit into a compact standard size briefcase. Each wheel can be dialed to a number, to every possible dial position, through a predetermined range of numbers. Programmed not to dial numbers in the forbidden zone. Four dialing speeds for loose and unlocked wheels

Dialer ITL 2000 II Kit ref. 00004

The advantages of electronic technology are here at last. Simply set-up the ITL2000II on any standard combination lock (dials right-left-right) with the easy-to-follow instructions and watch as the computer and drive motor go to work for you. Soon, the automatic dialer will have the lock open, saving time, materials and excess labor costs. The ITL2000II can cover the million conceivable combinations of a standard 3 number combination lock in under 30 hours. If one number is known, it can open single-function locks in less than an hour. Powerful enough to work on Mosler 302s.

Features:

- Lighter programming touch on the key pad
- Designed to work unattended
- Standard 120 V, 60 cycles (available in 240 V)
- 1 year warranty on workmanship and materials
- Auto shut-off when the combination is found



new!

The Safe Manipulator TSM ref. Assistant V3

This is a third Generation Manipulation Aid. Intended to assist the manipulator with manual combination safe locks. The Safe Manipulator TSM measures the contact point changes, gives a graphical display with high and low readings, and also a gives a visual display of the wheel positions. (This product requires the facility of loading onto a computer to function - therefore the product needs to be loaded onto your own computer or laptop.) The Safe Manipulator TSM has the ability to allow the operator to plot the circumference of each wheel. This product now has a resolution, such that, each division of a '0 to 100 dial' is divided into 40. (Currently has an accuracy of 4000 points per revolution). The Safe Manipulator TSM has the facility to store and save the settings, so that one can leave the job and then return.

The set contains:

Magnetic Stand, Program CD, Super Glue, Power Supply Unit, Rotary Encoder, Interface, Couplings Assembly.



Laptop or computer not included!

Stethoscope Lock Amp ref. LKM1116AMP

Amplified Stereo Listening Device.
This device features stereo magnetic microphones with volume control. The handsized amplifier attaches to a safe by a magnetic mounting plate. The lightweight stereo headset lets you hear those contact points and mechanism operations clearly.

Set includes: Amplifier, 2 magnetic microphones, Head-set, Batteries and Carrying case



Telescopic Picks

Set of telescopic picks to unlock two-lever safe locks. Made in stainless steel. The best picks in the market!



Telescopic Pick for SARGEANT & GREENLEAF
Telescopic Pick for STUV HAGLIN
Telescopic Pick for STUV VARYDSKYDD
Telescopic Pick for TANN BANKERS
Telescopic Pick for KROMA NOVUM
Telescopic Pick for ROSENGRENS ABN
Telescopic Pick for KROMA CONVAR
Telescopic Pick for POWER LOCK
Telescopic Pick for SLS MULTI STUMP
Telescopic Pick for SMP SUAN STUMP
Telescopic Pick for MAUER
Telescopic Pick for LIPS

ref. 8040
ref. 8041
ref. 8042
ref. 8043
ref. 8044
ref. 8045
ref. 8046
ref. 8047
ref. 8048
ref. 8049
ref. 8050
ref. 8051

Safe Opening Picks

The classic picks were developed further by our own technicians and is produced with biggest precision. With "your help" this tool opens the most lever locks. The lock can be picked without damage to the lock and no parts need to be replaced.

Pick PA 108

ref. pa 108

It's a 2 in 1 pick with hollow tip
 Long 92 mm dragging sleeve
 Long 56 mm feeling sleeve
 4 mm Ø Hole
 25.5 mm Ø Hole depth
 Outer 6.85 mm Ø
 Inner 5.45 mm Ø



Pick PA 112

ref.pa 112

It's a 2 in 1 pick with hollow tip
 Long 110 mm dragging sleeve
 Long 64,5 mm feeling sleeve
 4 mm Ø Hole
 27 mm Ø Hole depth
 Outer 6.60 mm Ø
 Inner 5.50 mm Ø

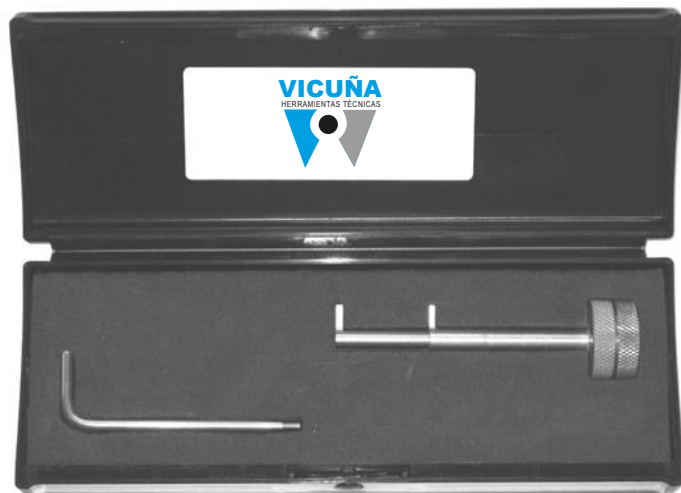

Pick Olle

ref. wh28c11

Pick for Olle lock safe



Safe Opening Picks



Pick PA 116

ref. pa 116

It's a 2 in 1 pick with normal tip
 Long 135 mm dragging sleeve
 Long 56 mm feeling sleeve
 11,2 mm dragging tip
 11,2 mm feeler tip
 Outer 4 mm Ø
 3.2 mm Ø dragging rod



Pick FAC

ref. 00111

It's a 2 in 1 pick with normal tip for FAC locks
 Long 121 mm dragging sleeve
 Long 85 mm feeling sleeve
 Double dragging
 5 mm Ø outer feeler
 3.2 mm Ø dragging rod



Pick ARFE

ref. wh28c02arf

It's a 2 in 1 pick with hollow tip for ARFE locks.
 Long 122 mm dragging sleeve
 Long 86,5 mm feeler sleeve
 Outer 7 mm Ø feeler
 Outer 5.5 mm Ø dragging sleeve
 30 mm hole depth
 Inner 3.97 mm Ø hole
 3.9 mm Ø Hole



Safe Opening Picks

Pick Polaszek 9G

ref. wh28c08

It's a 2 in 1 pick with hollow tip With dragging tip

123 mm long dragging sleeve

86 mm long Feeling sleeve

Outer 6 mm Ø

Inner 4.9 mm Ø

3,6 mm Ø Hole

25 mm hole depth



Pick Ferrimax

ref. wh28c07

It's a 2 in 1 pick with hollow tip

Long 193 mm dragging sleeve

Long 83 mm feeler sleeve

Outer 7 mm Ø

39 mm hole depth

Inner 5.5 mm Ø

4 mm Ø Hole



Pick wh28C02

ref. wh28c02

It's a 2 in 1 pick

123 mm long dragging sleeve

86 mm long Feeling sleeve

7 mm Ø outer feeler

Inner 5.9 mm Ø

4,1 mm Ø Hole

24 mm hole depth



Safe Opening Picks



Pick Arcu ref. wh28c09

It's a 2 in 1 pick
Special cobalt cutter with hollow tip
and depth stop. Quick opening with
smart breaking.

To be serviced easily. You can use
this pick in Arcu, Orenco locks, etc.
depending on the opening side of
the door. To work with this pick you
must have used
the Cobalt Cutter (ref. wh28fresa)



Pick Arcu ref. wh28c10

It's a 2 in 1 pick
Special cobalt cutter with hollow tip
and depth stop. Quick opening with
smart breaking.

To be serviced easily. You can use
this pick in Arcu, Orenco locks, etc.
depending on the opening side of
the door. To work with this pick you
must have used
the Cobalt Cutter (ref. wh28fresa)



Pick WH28C06 ref. wh28c06

It's a 2 in 1 pick with hollow tip With
dragging tip

123 mm long dragging sleeve

86 mm long Feeling sleeve

Outer 7 mm Ø

Inner 5.9 mm Ø

4,1 mm Ø Hole

24 mm hole depth

Safe Opening Picks

Pick Kromer Novum (Miralles)

ref. 00108

It's a 2 in 1 pick with hollow tip
 Long 355 mm dragging sleeve
 Long 280 mm feeling sleeve
 4,3 mm Ø hole
 60 mm hole depth
 Outer 7 mm Ø
 Inner 5,50 mm Ø
 Spoon-like dragging sleeve



Pick Kromer Convar (Miralles)

ref. 00108f

It's a 2 in 1 pick with hollow tip
 Long 355 mm dragging sleeve
 Long 280 mm feeling sleeve
 3,5 mm Ø hole
 60 mm hole depth
 Outer 5,45 mm Ø
 Inner 4,40 mm Ø
 Spoon-like dragging sleeve



Pick Pa 113

ref. pa113

It's a 2 in 1 pick with hollow tip with dragging tip
 91,5 mm long dragging sleeve
 56 mm long Feeling sleeve
 Outer 7,5 mm Ø
 Inner 5.9 mm Ø
 4,9 mm Ø Hole



Telescope Lens ref. 00702a

It is a great view aid when opening safes.
o 32 mm Ø Mirror
o From 16 cm to 61 cm long



Custom Pick for LaGard 2200 ref. pick LAG2200

The machining and design of this tool is exceptional. The tube and wheel manipulation tip are machined from stainless steel to give years of service to the safeman.



Wire Tool LDT LaGard 3600 ref. LDT 3600 TL

This tool is designed to open the lock if you have a lockout for any reason other than a failed solenoid, by directly energizing the solenoid wires and allowing the lock to be opened. This tool can also be used on other electronic locks, although it might require drilling somewhere other than the spindle hole.

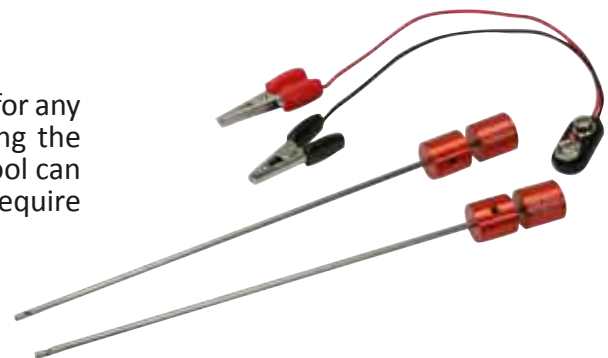

Safe Vibrator for Electronic Locks Safe Vibrator for Mod. Standard ref. SAFE-VIBRA-PEG For house safes

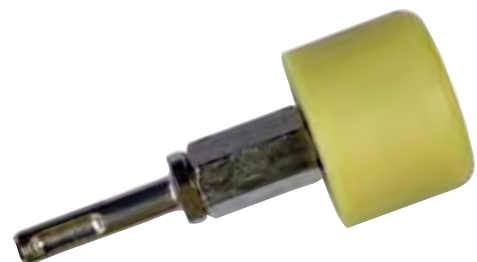

Safe Vibrator for mod. Strong ref. SAFE-VIBRA-VERS For big safes



Magnum Drill Rig ref. mag 45703



This drill rig can be used for template drilling or as a magnetic drill rig. The barrel is interchangeable between the two rigs. It allows you to get an easier and much closer view after drilling.

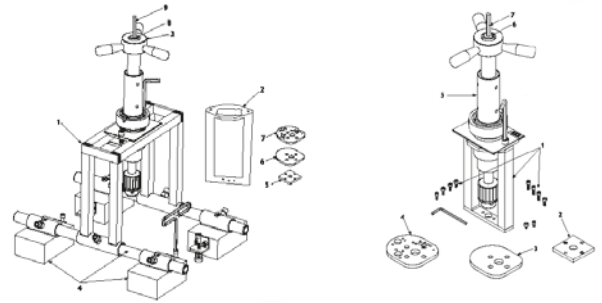

Power magnet ref. magnet pw1

Suitable to manipulate electrical or mechanical locks.

Notice:
Magnet fields can influence or damage also electronic systems like pacemakers, storage media, instruments, clocks etc..
Careful transportation and conscious application recommended.
No liability at improper use!

Manipulation Lock. 5 pins

This cylinder makes your learning and training easier.



Manipulation Lock "Standard", 5 pins

ref. 8110

Manipulation Lock "Easy", 5 pins

ref. 8110-2

Cylinder with screw caps Iseo/ Tesa ref. 01004is /01044te



This cylinder with screw caps has been designed to to put and remove pins. It's very suitable for picking practice.

Tool for Safes ref. JF combinaciones

Tool for opening safe combination locks. In only 15 minutes you can unlock the safe...with relocker.



Tool for Mauer 7111 ref. Mauer 7111

Tool for opening Mauer safe lock. No damage.
You can decode the lock, too.



Decoder for Mauer Variator ref. 8290

Tool to decode 8 & 11 lever locks





Decoder for STUV 7 ref. stuv-7

Brand new decoder specially designed for STUV 7
lever lock.

new!

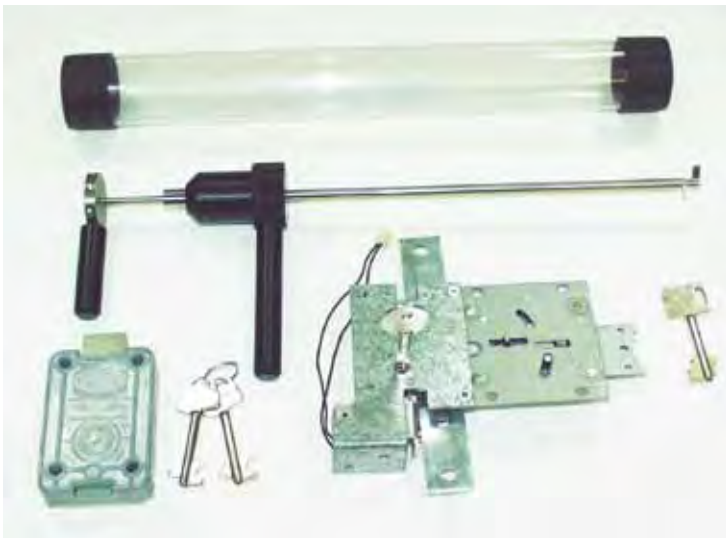

Pick for AGA & MAUER ref. 28349

Brand new tool specially designed for
unlocking, without damaging AGA mod.
0246 and MAUER mod. 74046 safe locks.

new!

Decoder for lever locks with "curtain" ref. 8288

Decoder for lever locks with "curtain"

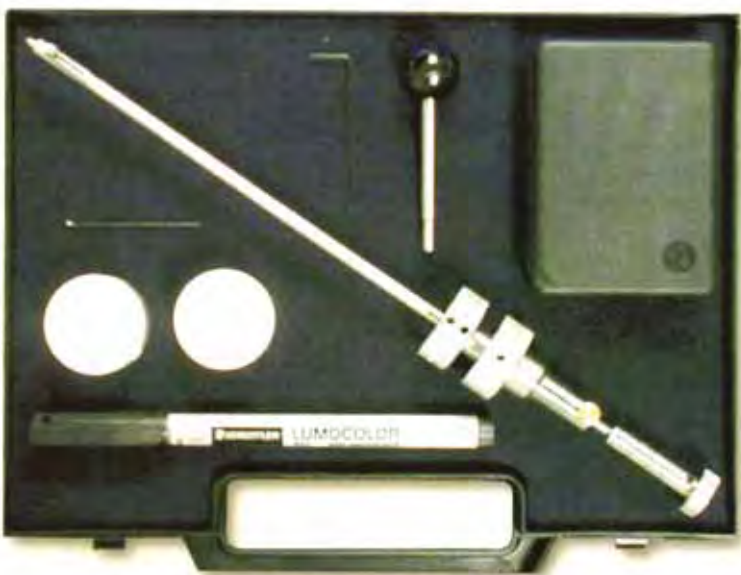

Pin & Cam

The term Pin & Cam refers to the original design, which used a small cam to apply lift to the pins in the key tip. The basic concept on which the system works is similar to that which is employed by the impressing technique.

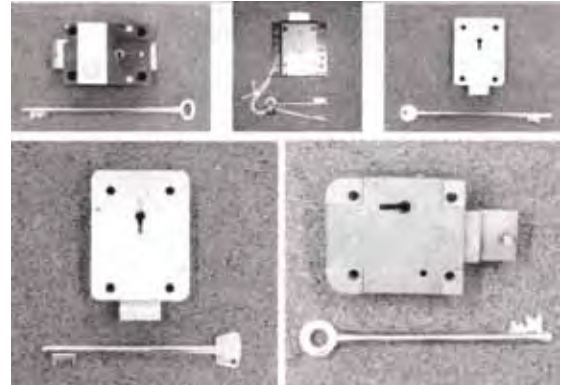
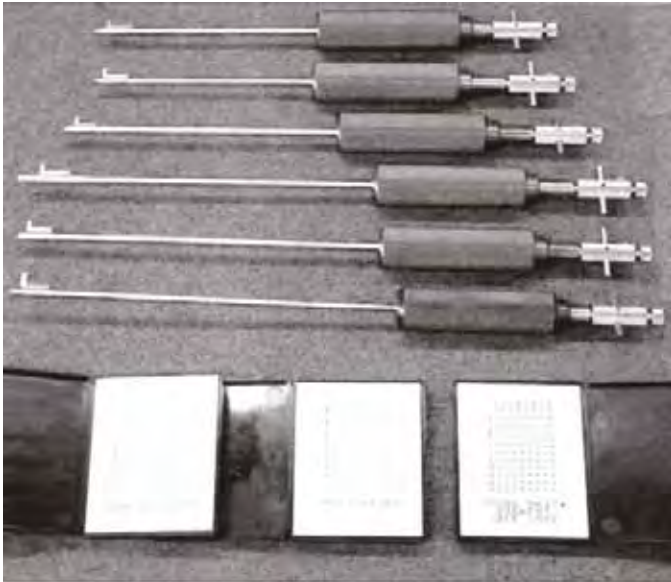

This method is without doubt the most effective way of defeating high security lever lock mechanisms. The system is easy to use, relatively quick and provides the user with a working key and code for future use.

- | | |
|---------------------------------|------------------|
| Pin & Cam for CHUBB model 6k174 | ref. 8280 |
| Pin & Cam for CHUBB model 6k75 | ref. 8281 |
| Pin & Cam for SLS, SMP y POWER | ref. 8282 |
| Pin & Cam for SMP | ref. 8283 |
| Pin & Cam for TANN | ref. 8284 |

Pick for Fichet ref. m2b m2i

You will be able to unlock the Fichet m2b m2i without damage with this tool.

Made in high quality steel by one of the best manufacturers in the World



This tool is currently out of catalogue.

We are manufacturing the new generation model

Paraplúie for pump locks

ref. 5511

Tool for 7 pump Pollux 7 lock

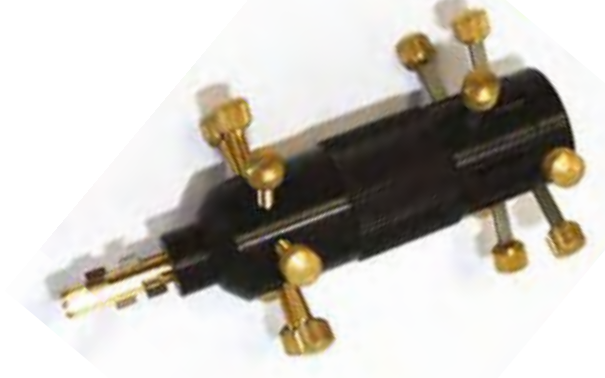

ref. 5512

Tool for 5 pump Pollux 5 lock



ref. 5514

Tool for lock 5-pump Izis 5



Parapluie for pump locks

ref. 5515

Tool for 5 pump Cavith 5 lock



ref. 5516

Tool for 7 pump Fontaine lock



ref. 5517

Tool for 5 pump & 1 pin JPM mod. 405 lock

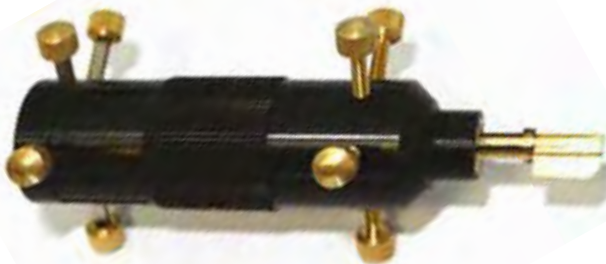

ref. 5519

Tool for 6 pump Laperche mod. Golf lock



Car Opener Tools

For the pulling of door buttons etc. The snare can be contracted using the pulling mechanism, thus allowing a tight grip on buttons, handles, etc. Given the very small diameter of the tool a small gap between door and frame is enough for successful and comfortable working.

Picture shows only partly image with handle and tip!



ref. 1596a
80 cm.



ref. 1596b
150 cm.



ref. 1596c
190 cm.



ref. 1596d
90 cm.



Wafer Reader

ref. 2525

Generate New Automotive Keys Without Removing Or Disassembling The Lock

The Wafer Reader works on cars using standard wafer style locks. Insert the tool into any door or deck/tailgate lock to quickly and efficiently read the lock tumblers. There is no need to purchase multiple tools.

One kit covers most domestic and import vehicles.

With just a few hours of practice, you can quickly generate keys for any car using standard wafer locks.

Just set up the reader and guide, insert them into the lock and pull out the reader to create a drawing of the key profile.

Use our gauges or site read the key profile to cut your key by code or simply attach the key template or drawing made with the Wafer Reader to the appropriate key and begin cutting with the Nibbler Key Cutter.



Car Opener Set Exclusive

ref. 1595

13 important car openers clearly arranged in a plastic carrying case.
Ideal for opening:

KIA, MAZDA,, PEUGEOT, ROVER, DAIHATSU, CITROEN, HYUNDAI, NISSAN, BMW, SKODA, VOLKSWAGEN,
OPEL, RENAULTLADA, SEAT, HONDA, FIAT, MITSUBISHI



Pick, 2-track Pick for VW

ref. VWEZ

This is a very simple to use pick for VW, Audi and Porsche vehicles using the HU66 Keyway, 2 Track internal High Security Key.

Simply insert the tension tool and then insert the pick blade and rake the wafers until the lock cylinder turns. These locks will pick to the unlock position easily.



Car Opener "Lazo"

ref. 7157

A 1,5 mts. tool for opening cars. Flexible.

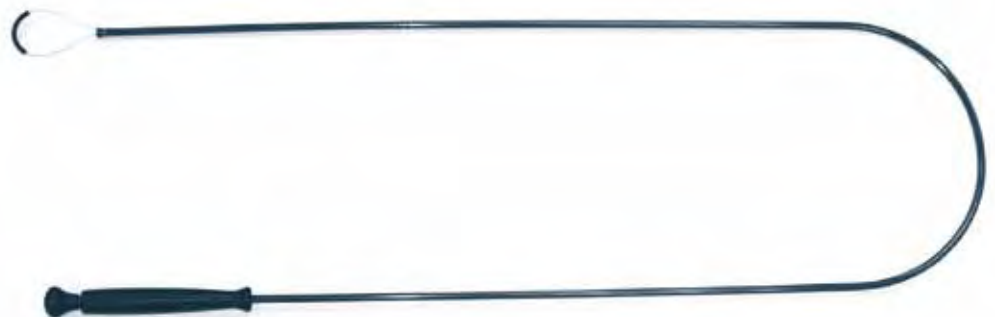

Car Opener Rods

The tool is unlike any other on the market. When the handles of this tool are separated, the hook at the end of the tool is pulled inward causing the tool to grip or bind the horizontal linkage rod.

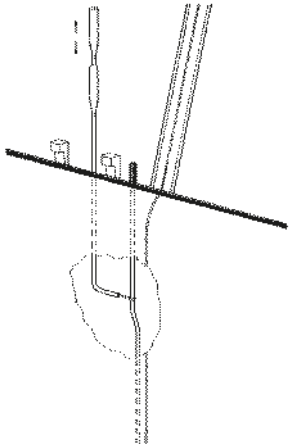

ref. 00752
Horizontal Rod Style

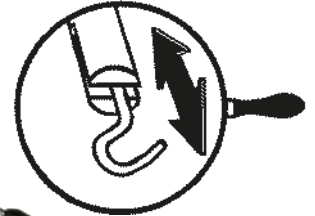

ref. 00753
Vertical Rod Style

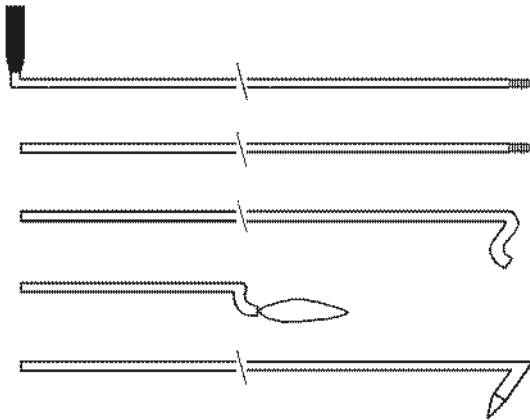

Car Opener Set ref. 00696

Set of bendable rods, especially designed to access handles, buttons, etc.

Power Keys



Power Keys for Group
VAG cars are available

ref. 0511
Fiat & Lancia

ref. 0512
Fiat, Alfa Romeo & Lancia

ref. 0513
Fiat, Alfa Romeo & Lancia

ref. 0514
Citroen & Peugeot

Car Tension Tool with Light ref.10220

This 2,7 mm Tool with LED light is specially designed for car opening. It has got side cuts to be set correctly.

new!



Professional Tension Wrench ref.0777- LKM- tn

This Tool is specially designed for car opening use which can provide locksmith very steady feeling. The tip of this strong tension includes 2 different necessary size of gaps to fit for every different car door cylinder.

Blade: High flexibility carbon steel material
Weight: 39 grams
Handle: Stainless steel



Double Car Tension Tool ref. 10046

New Tool designed for car opening.



Car Opening Light ref. rgn 3770

Owl Long Light is a Car Opening Light which is very high intensity can provide a very light view to help locksmith to inspect and watch inside a car door. Can also insert into hard-to-see area while car repairing.



Specification:
High quality aluminium alloy handle
Length of wand: 15.8" (40 cm) bendable wand
With the best Japanese new intensity LED white light
With a suction cup to attach on the glass of car
Weight only 86 grams, it can be put in the pocket
Operates continuously for 72 hours on a set of replaceable batteries.

Mini Premium ref. 00705

Outstanding tool for plug extraction of car ignition locks.
o Small measurements
o Traction forces are exactly measurable
o Ideal for wrecking-services and exploitation companies



Car Opener ref. 00700

With this extraction tool door locks and ignition locks can be removed quickly. Subsequent opening and starting of the vehicles are possible with a screwdriver. Each expert knows how difficult and time consuming the milling out of the ignition lock can be and how time-consuming and ungrateful these works are. This technique also uses the ZIEH-FIX® Pull Screws, which are screwed into the keyway. The tool can also be used with locks in the handlebars of motorbikes. Finally you can avoid splinters in the bearing of the bike's handlebars

o Also suitable for motorcycle locks - no more chips in the steering tube
o Delivery with Percussion Hammer of 600 g weight
o Ideal for wrecking-services and exploitation companies
o additionally a Percussion Hammer of 1600 gram weight is available



Ref.	OPTIONAL description
00214	Screw Standard
00215	Screw Extra
00216	Screw Super

Turbo Decoder Grupo VAG 1st Generation ref. TurboDEC1

Turbo decoder for decoding and opening.
For VAG 1st locks generation (up to 2006-2007)
After the opening the operator can read the
actual lock code and can cut a working key.

Key Reference: HU66

new!



Turbo Decoder Grupo VAG 2nd & 3rd Generation ref. TurboDEC2/3

Turbo decoder for decoding and opening.
For VAG 2nd & 3rd locks generation (from 2006/07 on)
After the opening the operator can read the
actual lock code and can cut a working key.

Key Reference: HU66

new!



Turbo Decoder BMW ref. TurboDEC4

Turbo decoder for decoding and opening.
For BMW locks generation.
After the opening the operator can read the
actual lock code and can cut a working key.

Key Reference: HU92

new!





New Turbo Decoder BMW ref. Turbo BMW/F

Turbo decoder for decoding and opening.
For new BMW series F with key HU100R

new!



New Turbo Decoder Opel ref. Turbo Opel

Turbo decoder for decoding and opening.
For OPEL & Chevrolet cars with key HU100

new!



Turbo Decoder Tester Keys

If you want to use your Turbodecoder easily, try the tester keys! You can use them to know which key is for and which side to use with the Turbodecoder.

Tester Key VAG HU66
ref. Turbollave1

Tester Key BMW HU92/ HU83
ref. Turbollave2

Advanced Scooter Workshop ref. MBEK-LINE

Advanced Scooter Workshop is a K-line tool that incorporates ignition control unit (CDI) internal memory modification functions without cutting its plastic package, scrape sealant, soldering any wires or de-soldering memory IC. All you have to do is to connect four wires to controller connector.



New!

For Scooters!

OBD Tester ref. MBEOBD

OBD Tester - Force ignition tool for VAG cars. So just plug the tool into the OBD on the car and press the test button and will tell you if there is a short in the OBD. Now insert your diagnostic tool and carry on with key programming in the normal way.



New!

Wireless!

Ecodecoder GM HU100 ref. ecodecoder

This Ecodecoder offers you a clean and fast opening of the vehicle – unlock & lock as many times as necessary. Suitable for GM cars with **key HU100**.



New!

Ecodecoder F-Serie ref. ecodecoder1

This Ecodecoder offers you a clean and fast opening of the vehicle – unlock & lock as many times as necessary. Suitable for BMW Series F cars with **key HU100R**.



New!

Abrites ref. abrites

ABRITES Vehicle Diagnostic Interface in abbreviated AVDI is last generation diagnostic interface for vehicles produced from our company.

The interface is designed to communicate with almost vehicles on the market via diagnostic link.

AVDI is compatible with all vehicle diagnostic software produced from our company – ABRITES Commander for VAG, ABRITES Commander for Porsche, ABRITES Commander for Toyota, ABRITES Commander for BMW, ABRITES Commander for Renault and s.o.

new!



Orange 5 ref. orange5

Orange5 is a professional programming device for memory and microcontrollers. Unique feature of the current series programmers is built-in macrolanguage for writing down protocols, which gives fast and easy capability to add new types of microschemes, precisely meeting manufacturers' requirements to read/write algorithms.

New!



Key Scan ref. keyscan

The Key Scan is an invaluable tool for automotive locksmiths, garages, and body shops, you can now program keys and remote without having to transport vehicles to the main dealer.

The Key Scan has been designed to be quick and easy to use, it uses one main harness for all 16 pin vehicles, so you won't need to swap leads or add additional pods or modules, when working with 16 pin cars.

with battery tester!



new!

SKP-900 ref. skp900

SKP-900 Key Programmer is Hand-held OBD2 key programmer. SKP-900 Key Programmer can support almost all cars in the world, such as Ford, Land Rover, Chrysler, Jeep, Toyota, Nissan, Honda, Mitsubishi, Hyundai, Kia, and so on.

new!



Pick for Cars

New picks for car lock opening.

CAR MODEL

BMW (new model)
 BMW (old model)
 BMW SERIE 2010 new model
 BMW SERIE 7,MINI, MG
 CAMERY HOLDEN
 CITROEN
 FIAT STILO
 FORD FOCUS
 HONDA
 HONDA LEGEND
 HYUNDAI (old model)
 HYUNDAI (new model)
 KIA
 KIA OPIRUS
 LEXUS (old model), TOYOTA
 LEXUS (new model)
 LEXUS (new model)
 MAZDA
 Mercedes BENZ (old model)
 Mercedes BENZ (new model)
 Mercedes BENZ (new model) EXTRA LONG
 OPEL (old model)
 OPEL (new model)
 PEUGEOT
 PEUGEOT 306 406
 SAAB (new model)
 SAAB (old model)
 VOLVO,FORD EXTRA LARGO
 VOLVO (new model)
 VOLVO (old model)
 VW(1)
 VW(2)

REFERENCE

HU92
 HU58
 HU100(R)
 HU92(10)
 TOY43
 VA2T
 SIP22
 HU10
 HON66
 HON60
 Hyundai
 Hyundai(3)
 KIA
 TOY40
 TOY40(2)
 TOY 2 TRACKER
 TOY48
 Mazda
 HU39
 HU64
 HU64(10) v.2
 HU43
 HU100(10)
 HU83
 NE78
 SAAB(2)
 YM30
 HU101(10)
 NE66
 HU56
 HU66(1)
 HU66(2)



A complete set including these picks is available for you.

We have picks for almost all the models in the market.
 Please, ask for other models.

We are LISHI original distributors .



2-in-1 Pick and Decoder

Decoders for cars.

Reference

HU66 2-IN-1
HU92(10) 2-IN-1
SIP22 V.2 2-in-1
NE78 2-in-1
VA2T 2-in-1
HU100(10) 2-IN-1
HU64 2-IN-1
HU101(10) 2-IN-1
HU58 2-IN-1
Toyota2 2-in-1
TOYOTA 48 2-IN-1
HON66 2-IN-1

Car model

VAG gen1 & 2
BMW with 7 serial
FIAT stilo
Peugeot 406,307
Citroen
Old Opel
New Benz
Volvo, Ford
Old BMW
TOYOTA 2 TRACKER
NEW LEXUS
HONDA ACURA



HU83 2-IN-1
TOY40 2-IN-1
TOY43 2-IN-1
RENAULT 2-IN-1
MINI/MG 2-IN-1
Hyundai (HY22) 2-IN-1
Renault(A) 2-in-1
GT15 2-IN-1
NE72 2-IN-1
NSN14 2-IN-1
HYN7R 2-IN-1
HY16 2-IN-1
YM28 2-IN-1
HU46 2-IN-1
MAZDA 2-IN-1
MIT8 2-IN-1
NE66 2-IN-1
HU100(R) 2-IN-1
MIT11 2-IN-1

PEUGEOT
OLD LEXUS, TOYOTA
02YEAR ONWARD TOYOTA LEXUS
RENAULT LAGUNA
BMW MINI, MG and Rover 75 car
Hyundai cars
Renault LAGUNA 2, Megane, Clio
FIAT Punto, Brava, Pali, Coupe, etc
Citroen, Nissan, Peugeot, Renault, Vauxhall
NISSAN, CHEVROLET EPICA, SUBARU
HYUNDAI/KIA
HYUNDAI
GM BUICK
OLD DAWOO
OLD MAZDA
Mitsubishi, Suzuki, Isuzu.
NEW VOLVO
NEW BMW 2010 SERIAL 5 AND 7
Mitsubishi, Suzuki, Isuzu, Nissan
Luxgen, Chrysler, Dodge, Eagle, Olymouth, Porton, Mazda

We have picks for almost all the models in the market.
We are LISHI original distributors .

Software for Order No. 880-BMW-KPR ref. 880 soft KPR

The software is now on the USB dongle. So you can install the software on several computers. Depending on the computer you want to use you only have to insert the USB dongle.

oWith this software the newest automotive locks could be decoded. After the determination of the code with the corresponding decoder the read code is to enter in the programme. The software converts the code and announces some suggestions of key codes.

One matches!

BMW - 2005 on

At present only for Windows versions up to XP available!



BMW Precision Car Opening and Decoder Kit ref. 880 bmw2- KPR

This precision kit was built specially to cater the increasing demand for a solution to the new high security BMW locks. When there is no keys or when the keys are in the car (passenger compartment or boot).

The Kit contains:

- o 1 Decoder
- o 16 half keys which cover all combinations available for all BMW cars with 2 track locks.
- o Writing charts
- o Solid head
- o Hex screwdriver



VAG Precision Car Opening and Decoder Kit ref. 880 VAG- KPR

This precision kit was built specially to cater the increasing demand for a solution to the new high security VAG locks. When here is no keys or when the keys are in the car (passenger compartment or boot).

The kit contains:

- o 1 Decoder
- o 28 half keys which cover all combinations available for all VAG group cars
- o Writing charts
- o Solid head
- o Transponder head
- o Hex screwdriver



European Lockmaster® I.D. Badge Case ref. 3007

On the first side of the case there is a window that protects an identification card and on the second side you find the "Lockmaster®" Star.

oGold plated

oShirt Pocket Size (closed): 10.5 x 8.5 cm

oDiameter of the "Lockmaster® Star": 5.5 cm



Car Opener Big Jim ref. 00720

It has prescribed depth graduations on its face to find exact pick up points.

o the classic opener!

o new production because of high demand!

o manufactured of high-quality spring steel



Pick Master ref. 00790 master

Pick for unlocking car locks.

A very useful tool to practice the jiggleing technique.



Decoder for TIBBE Version De luxe ref. 00791

The Ford Tibbe Decoder Pick is a modified Wheel Pick which is capable of opening and decoding both the Ford 6 disc and Jaguar 8 disc versions of this locking mechanism. The system can be used on the doors, the boot or the petrol cover. We suggest that it be used on the front driver or passenger doors.



Once the door has been successfully opened the tool can be used to identify the locks code so that a key can be constructed for further entries. The system can be used as a kind of variable key so that the lock can be opened a second time without a key and without the requirement to re-pick the mechanism. The system will also work on both the old and new versions of this lock unlike other systems which have been developed recently.

Autosleeve ref. 00691



The Auto Sleeve helps prevent damage to weather stripping and automobile finish. This hardened plastic interlocking envelope is ideal for separating weather stripping from door frames or windows without damage. Once in place, the Auto Sleeve gives you a protective tunnel to insert your car opening tool without worry of scratching or damaging your customer's car. The Auto Sleeve works very well in conjunction with the Pump Wedge (ref. 00799)

Auto Wedge

Auto Wedges are designed for smooth, safe insertion and will not fall into door cavities. The special angled tips allow for easier insertion and the sure-stop edges stop you from pushing these wedges in too far.



ref. 00808 9,5 mm Thick
ref. 00807 19 mm Thick



ref. PW100 POWER WEDGE

Power Wedge is a spring loaded compound lever that safely spreads a vehicle door away from the body, allowing for the easy entry of a "Through the Car" opening tool. It slides into the opening between the vehicle's door and frame at the top of the door. The rubber-coated ends protect the vehicle from scratches and the adjustment knob allows you to control how wide you need the door to open.

Simulator Set ref. 00790

A set of 14 jiggler keys to help open all kind of cars as well as numerous other locking devices. Works on both pin tumbler and wafer mechanisms.



Jigglers Car Key Jigglers ref. 00789

A set of 10 jiggler keys to help open all kind of cars as well as numerous other locking devices. Works on both pin tumbler and wafer mechanisms.



Suction Cup ref. 00695

Suction Cup with very high capacity.
Ideal for the opening of cars.

- powerfull and easy to use!
- Diameter: 120 mm



Air Wedge

The heavy-duty construction and the simple, push-button operation makes this the best inflatable wedge on the market.

ref. 00799

15.8 cm x 14.3 cm (width x height), 5.629" x 6.22"



ref. 00799 big

28.9 cm x 12.4 cm (width x height),
11.377" x 4.881"



ref. 1526-2-1

"2 in 1", 24.0 cm x 15.3 cm
(width x height), 9.45" x 6.02"



Auto Pick Set for VAG - from model 1997 on ref. 0600-VAG-set



5 pieces Multi automotive picking tools

- For left and right turn.
 - Top Grain Leather Case with Snap
- For vehicles until model 1997 of:
Audi, Ford (only Galaxy), Porsche, Seat, Skoda, VW

Tension Wrench not included!

"Jack Master" Little Joe Pick Set "Jack Master" Little Joe BMW Pick Set ref. 0555-MJ-BMW-KIT



"Jack Master" Little Joe OPEL Pick Set ref. 0555-MJ-OPEL-KIT

"Jack Master" Little Joe VAG Pick Set ref. 0555-MJ-VAG-KIT

Tool for pushing the handbrake

ref. 7158

Tool for pushing the handbrake and release it



Book "Easy Picking"

ref. EPES

An Excellent Training Guide
Easy to Understand
Step by Step Instructions
Full Colour Instructions
Simple Application
Practice Tips & Tricks

new!

Available in English, too.



Book "The Secrets of Locksmithing"

ref. 00163d

This book describes in detail the theories and techniques for unlocking cylinders.
Available in Spanish.



Book "Safe Manipulation"

ref. 00163c

This book describes in detail the theories and techniques for safe manipulation.
Available in Spanish.





CDs ZIEH-FIX

ref. 00218

- Destructive opening techniques:
- o Pull-off techniques with ZIEH-FIX®
 - o Milling of locks and door fittings with rotary grinder
- o Accesories and tools
- Non-destructive opening techniques:
- o Window opener
 - o Door latch opening needle
 - o Lever opening tool
- German



ZIEH-FIX Electro Pick

ref. cd 4000

- Non-destructive Opening Techniques:
- o Elektro-Picking at Round- and Profile Cylinders
 - o Accessoris and Tools
 - o Tubular Pick
 - o Cross Pick
 - o Hobb´sche Hooks
 - o Door Latch Opening Pick Needle
 - o Lever Opening Tool
 - o Window Opener
 - o Padlock Buster.
- German



Safe & Tresor

ref. 04501

- Destructive opening techniques:
- o Ultrathermic Cutting System
 - o Drilling and Milling
 - o Accesories and Tools
- Non-destructive opening techniques:
- o Dialer
 - o Hobb´sche Hook
- 35 minutes, German



CD Vicuña

ref. cd/vicu

Video CD about how some Vicuña tools work, besides some information on the Spanish Company Vicuña Herramientas Técnicas.

Safe Opening Manuals

These books help the user get the best results in the shortest possible time, by using the proper procedures. It includes combination changing information for Diebold, Eagle, HHM, S&G, Yale, and York safe locks.

Story of Safe Deposit Box Locks

ref. 00160

Safe Combination Changing

ref. 00161

Safe and Vault Manual

ref. 00162

The Art of Manipulation

ref. 00163



Safe and Vault Manuals

Ed Willis, Safe and Vault Manual, Volume I

ref. 04711

This volume contains drawings of domestic safes and vaults, plus imported safes from 'B' and 'C' rated to TL-15 & TL-30 money chests.

Ed Willis, Safe and Vault Manual, Volume II

ref. 04712

Volume 2 includes 128 drawings (40 locks - 31 key locks & 9 combination locks). Information on operation, changing combination or keys is included where appropriate. Also included are 15 full size door drawings on 11"x17" fold-out pages.

Schlösser und Tresore

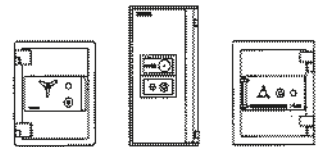

von Ed Willis

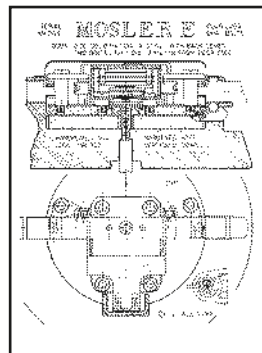
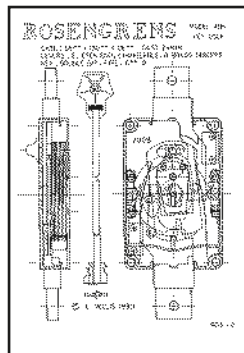
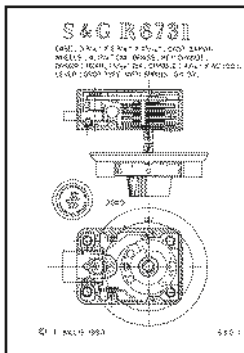



Book "Basic Picking and Raking" ref. 00800

This book describes in detail the theories and techniques for picking standard pin and wafer tumbler locks. All the necessary tools, such as picks and tension wrenches, are listed and fully illustrated for convenient cross-reference.

Available in English, German and Spanish.

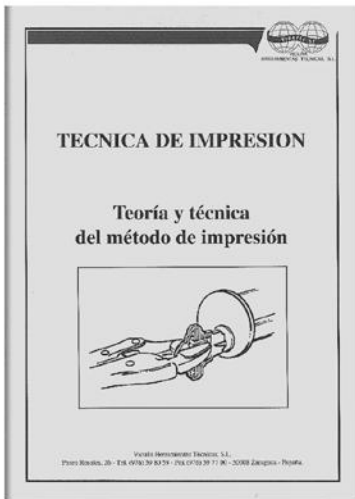

Book "Basic Impressioning" ref. 00554

This book explains the fundamental theories and methods for making a key with this method. The proper technique for blank preparation (spacing), obtaining marks and the ability to recognize marks are covered in detail.

Available in English, German and Spanish.



Book "Impressioning" ref. ref. 3054-gb

Book in English and German about impression techniques.

Books on Locks

Art Treasures ref. Buch-Schell 1

Keys, locks, treasure boxes and mounts
Text in German and English, 170 pages, more than 250 pictures, many illustrations about the function of locks and padlocks.

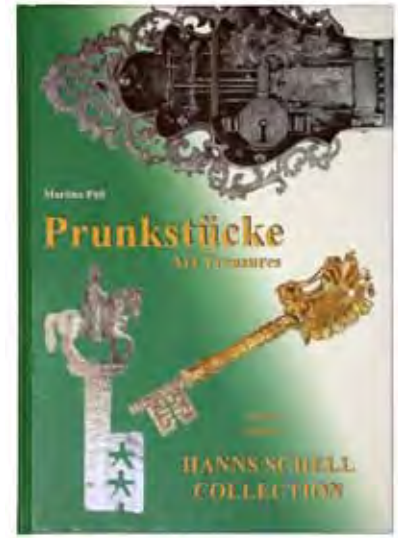

American Genius ref. Buch-Erroll

On West 44th Street in New York City, on the second floor of the General Society of Mechanics and Tradesmen building, rests an extraordinary display of American craftsmanship and ingenuity from the nineteenth Century: the John Mossman Collection of bank vault locks and time locks. Designed to protect America's riches from every threat, these beautiful devices embody the evolution of lock technology during the nineteenth Century, its most creative period. Many of the handcrafted masterpieces are elaborately decorated with intricate engraving and casting, despite the fact that their mechanical interiors would rarely be seen. They reflect the great pride in creative workmanship and the mechanical genius that characterized American industry at the time. The famous Parautoptic lock with its eighty-three moving parts remained unpickable for ten years until Linus Yale learned its weaknesses and exposed them to the public in the pages of the Boston Post. The Double Pin Dial time lock of 1875 could be set to lock or unlock automatically at every hour of each day, and for an extra \$50, a "Sunday Attachment" would allow the lock to remain locked every seventh day. With the United States' entry into World War I, safes and their locks were often melted down; as a result the Mossman Collection is home to many one-of-a-kind masterpieces. American Genius is the most complete survey of these marvels of complexity and their dramatic history. Detailed text by Mossman Collection curator John Erroll and his son David is illustrated by more than four hundred luminous photographs, the first formally approved color imagery of the collection, by Anne Day. Drawing on newly uncovered original sources, the authors offer an in-depth look at the incredible range of the lockmaker's art, from some of the most complex key mechanisms to the most advanced four-movement time locks. American Genius is a meticulous and fascinating exploration of a remarkable but little-known chapter in American technological achievement.

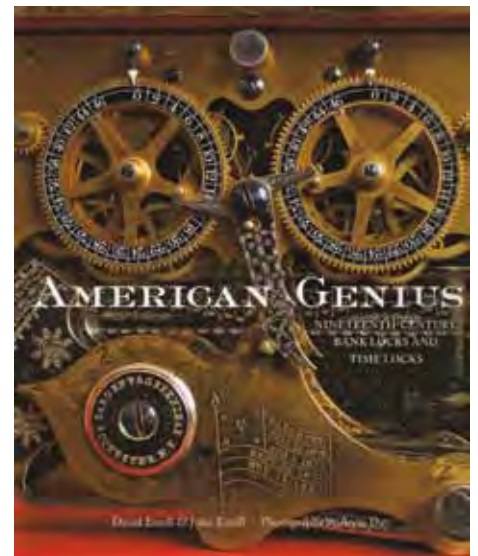

Books on Locks Art Treasures

Locks, Safes & Security ref. Buch-LSS+

- o International Police Reference
- o English version only!

The 2nd edition of this book has been widely used by law enforcement agencies and forensic labs world-wide. Locks and safes are covered in detail, including their construction, design and bypass techniques.

Available to Government Agencies only!

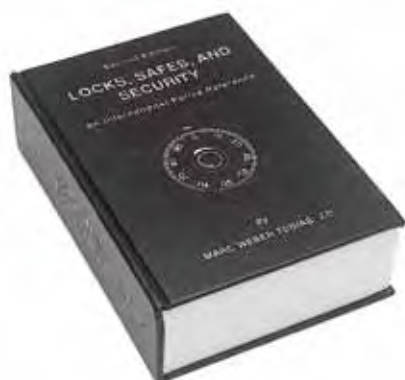

Car Opening DVD WENDT I, 1993

ref. 00610

Up to 44 different makes.

VHS, PAL, duration: 70 Minutes, German

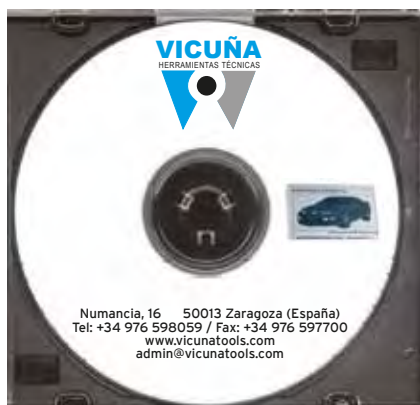

Audi 80, Bj. 93 • Audi 100, Bj. 93 • BMW 520i, Bj. 93 • Fiat Uno, Bj. 93 • Ford Fiesta, Bj. 93 • Ford Escort CL, Bj. 93 • Ford Mondeo, Bj. 93 • Honda Civic, Bj. 93 • Honda Accord ES, Bj. 93 • Honda CRX Coupé, Bj. 93 • Mazda 323, Bj. 91 • Mercedes C180, Bj. 93 • Mercedes 230 E, Bj. 93 • Mercedes 500 SEC, Bj. 89 • Mercedes 500 SL, Bj. 93 • Mercedes 500 SEL, Bj. 93 • Mitsubishi Lancer, Bj. 93 • Nissan Micra, Bj. 93 • Nissan Primera, Bj. 93 • Opel Corsa, Bj. 93 • Opel Astra, Bj. 93 • Opel Vectra, Bj. 93 • Opel Calibra, Bj. 93 • Opel Omega, Bj. 93 • Peugeot 106 XR, Bj. 93 • Peugeot 306 XN, Bj. 93 • Porsche 911/2 Carrera, Bj. 93 • Renault Twingo, Bj. 93 • Renault Clio, Bj. 93 • Renault 19 TSE, Bj. 93 • Renault Espace, Bj. 90 • Seat Marbella, Bj. 93 • Seat Toledo GLX, Bj. 93 • Skoda Forman LX, Bj. 93 • Suzuki Swift Limousine, Bj. 93 • Suzuki Swift Coupé, Bj. 93 • Toyota Corolla, Bj. 93 • Toyota MR 2, Bj. 93 • Volvo 850, Bj. 93 • VW Polo, Bj. 93 • VW Golf II, Bj. 92 • VW Golf III, Bj. 93 • VW Passat, Bj. 92 u. Bj. 93

WENDT II, 1997

ref.00611

Nearly 40 different makes.

VHS, PAL, duration: 63 Minutes, German



Audi A3, Bj.96 • Audi A8, Bj 97 • BMW 323i, Bj. 96 • BMW 528i, Bj. 96 • BMW 728i, Bj.96 • Chrysler Voyager, Bj. 97 • Citroen Xantia, Bj. 96 • Daihatsu Charade, Bj. 97 • Ferrari F355 berlinetta, Bj. 96 • Fiat Brava, Bj. 97 • Fiat Cinquecento, Bj. 97 • Ford Escort, Bj. 96 • Ford Fiesta, Bj. 96 • Ford KA, Bj. 96 • Ford Mondeo, Bj. 96 • Jaguar XJ6, Bj. 96 • Mazda 323, Bj. 97 • Mercedes E230, Bj. 97 • Mercedes SLK, Bj. 97 • Mitsubishi Space Runner, Bj. 96 • Opel Astra, Bj. 97 • Opel Vectra, Bj. 95 • Peugeot 806, Bj. 95 • Porsche 911 Carrera, Bj. 97 • Renault Espace, Bj. 96 u. Bj. 97 • Renault Laguna, Bj. 97 • Renault Megane, Bj. 97 • Renault Rapid, Bj. 97 • Rover 416, Bj. 95 • Seat Cordoba, Bj. 96 • Toyota Carina, Bj. 96 • Toyota Picnic, Bj. 97 • VW Passat, Bj. 96 • VW Polo, Bj. 96 • VW Sharan, Bj. 96

Masterkeying

Masterkeying is an integrated locking system in which a cylinder can be opened by more than one different key. Thereby allowing control of user access by more than one staff member, whilst maintaining the convenience of using a minimum number of keys.

With an adequate locking plan each cylinder is opened only by the keys, and consequently only by the people desired.

The masterkeying does not increase the physical security of the lock, this is taken care of by the access system itself, but it does establish control.

For this reason it should be, first and foremost, functional and simple, in order to ensure security and allow for expansion.

You can order your master key systems right now!

Orders will be delivered as soon as possible. In about 2 days time

OPTIONAL:

- Cylinder and Key Carving (names or numbers)
- Masterkeying
- Code Keys

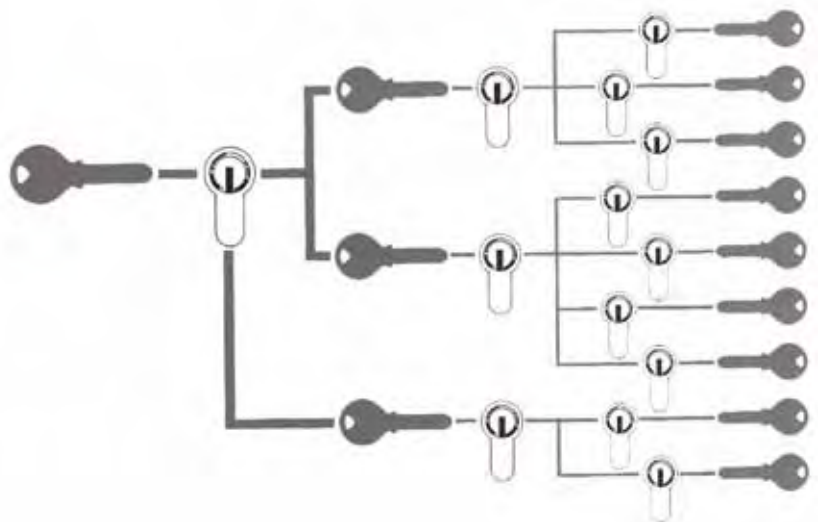

Training Courses

General Opening Technique

Trained by José Luis García de Vicuña

Duration: 2 days

(Timetable: 10-19h)

Number of Students: 4 people

CONTENT:

Basic notions of different kinds of locks.

Lever & pump locks.

How does a cylinder work? Parts and lock case (dismantle).

Cylinder alignment.

Preparing a master key system.

Unlocking cylinders with extractor tools.

Shield Protection Manipulation

How do we unlock with Electro-picking?

Tubular locks.

Hand picking.

Bumping Technique

Unlocking Tricks.

This Training Course includes 1 HOTEL NIGHTS, BREAKFAST AND 2 DAYS LUNCH.

Lever Locks Opening

Trained by José Luis García de Vicuña

Duration: 2 days

(timetable: 10-19h)

Number of Students: reduced groups

Tools (included in the price)

Kitbor Kit

Magic Key 2 for Mottura +6+ - Nucleo

CONTENT:

Use of the latest techniques and tools to unlock without damage the most of the lever locks in the market.

Very interactive course.

This Training Course includes 1 HOTEL NIGHT, BREAKFAST and 2 DAYS LUNCH.



Training Courses

Car Special Course

Trained by José Luis García de Vicuña

CONTENT:

Duration: 3/4 days (usually 10-19h)

Number of Students: 8/10 people

Unlocking real car locks.

Mercedes, BMW, Ford Tibbe, Ford C-Max, Audi, Renault, Peugeot, Citroën, etc.

Decoding the cutting of the key by using the latest techniques with decoders.

Key programming and copying.



Car Opening (Only Opening)

Trained by José Luis García de Vicuña

NEW CONTENT:

Duration: 1 days (usually 10-19h)

Number of Students: reduced people

Unlocking real car Locks.

Mercedes, BMW, Ford Tibbe, Ford C-Max, Audi, Renault, Peugeot, Citroën, etc.

Decoders. Different picking techniques.

This Training Course includes 1 Hotel Night, Breakfast and Lunch

Safe Manipulation

Trained by José Luis García de Vicuña

CONTENT:

Duration: 3 days (usually 10-19h)

Number of Students: reduced people

Introduction to safes. Identify a safe.

Safe picking.

Changing combinations.

Wheel combination manipulation.

Drilling safes.

Use of techno-endoscope.

Introduction to digital combinations.

This Training Course includes 2 Hotel Nights, Breakfast and 3 Days Lunch.



Training Courses

Impression Techniques

Trained by José Luis García de Vicuña

Duration: 3 days (USUALLY ON WEEKEND: FRI: 10-19H, SAT: 9-20H,
SUN: 9-13H)

Number of students: 6 people

Tools (included in the price):
Mini Drill Proxxon, 5 mm Burr,
Special Files for Impression Technique,
Key Blank Holder, Optical Impression Technique Instrument.

This Training Course includes 2 Hotel Nights, Breakfast and
3 Days Lunch.

Masterkeying

Trained by José Luis García de Vicuña

Duration: 1 day
(10-14h & 16-19h)

Number of Students: 2 people

Masterkeying is an integrated locking system in which a cylinder can be opened by more than one different key. Thereby allowing control of user access by more than one staff member, whilst maintaining the convenience of using a minimum number of key

This Training Course includes 1 Hotel Night, Breakfast and Lunch



Vicuña Group

Trying to improve ourselves continually in order to give our clients a better service, we decided some years ago to broaden our horizons in the locksmithing services and activities with the only goal of satisfying the needs of our job: locksmithing.

That's why the so-called Vicuña Group was born. The idea was to create a big and strong group of professional locksmiths who would have a series of services and advantages:

- Free Subscription to our issued Newsletter, where you can find news, techniques or new tools in the market.
- Discounts in tools and training courses prices.
- Counselling Service in the Car, Door and Safe Opening
- Vicuña Group have exclusive cylinders and key profiles.
- Possibility of sign in a group civil insurance (cheaper than an individual one)
- Special Offers for the Members.
- Vicuña Group Identity Card.
- Possibility of direct contact and address among the members of the Group
- Annual Meeting of all the Vicuña Group Members.
- Information through Social Net Services

Web and Social Networking

www.vicunatools.com

Vicuña Herramientas Técnicas is on the net, with a renewed and modern service, where you will find all our tools, training courses, the members of our Group, and now a chat where you can share your professional ideas with all around the world locksmiths. Technical Assistance

facebook & twitter



Vicuña Herramientas Técnicas is on the Social Networking, in Twitter and Facebook, to share our offers, our training courses information and our information about events where Vicuña is.

Follow us in Facebook and Twitter. Join us to share our friends and members thoughts.

Purchase Conditions

All goods are forwarded at buyer's cost and risk under our discretion without our obligation for the cheapest or safest shipment. Shipment is always carried out at buyer's risk.

The buyer has to inspect the goods immediately upon receipt especially regarding weight, number of items and outward appearances. In case of justified written notification within 15 days after receipt of goods regarding provable material or performance faults we can either decide to rectify the fault without cost to you or after return of the goods we can either send new goods ex work or credit the amount of the returned goods. In that case Vicuña Herramientas Técnicas S.L will contract the shipment company. All further claims whatever they may be, especially regarding rescission, abatement or compensation in damages - even in cases of special guarantees or promises- are excluded. Please note that CDs, videos, books and used tools are non-returnable.

Every order must imply the acceptance of our sales conditions.